

Homeowner's Combined Information Guides



Enclosed Publications Include:

- **Residential Environmental Hazards—**
A Guide For Homeowners, Homebuyers, Landlords and Tenants
California Environmental Protection Agency - 2011 UPDATE
- **Protect Your Family From Lead In Your Home**
United States Environmental Protection Agency
- **Homeowner's Guide to Earthquake Safety**
State of California Seismic Safety Commission
- **HERS - What is Your Home Energy Rating?**
California Energy Commission



CALIFORNIA ASSOCIATION OF REALTORS®

User Protection Agreement

The California Association of REALTORS® (C.A.R.) stands behind its, and its California-based subsidiaries, forms* and publications*. C.A.R., as noted in the paragraph below, will assist the user of its Standard Forms and Publications, or the user of the forms and publications of its California-based subsidiaries, in defense of any claim, on appeal, that any pre-printed provision of the latest version of the printed or computer-generated forms or publications (1) for non-statutory forms or publications, is unlawful or (2) for statutory forms and publications, did not meet the statutory/regulatory requirements at the time of printing. This coverage does not apply to the manner in which a person completes the blank provisions of the forms, but rather to the lawfulness of the pre-printed clauses themselves.

This User Protection Agreement (1) applies only to the latest version of the forms and publications used in property transactions in California by persons who have obtained or purchased the forms or publications consistent with C.A.R.'s, or its California-based subsidiaries, copyrights and (2) means solely that C.A.R. will argue that the pre-printed provisions are lawful or meet statutory/regulatory requirements at the time of printing through an amicus curiae brief on appeal, or will provide funding for that portion of the appeal attributable to claims that the pre-printed provisions are unlawful or did not meet the statutory /regulatory requirements, or both, in the discretion of the C.A.R. Legal Action Fund Trustees.

*Forms and publications include only those written by C.A.R., or its California-based subsidiaries, and those required or permitted to be given in a transaction by statute, where the language of the form or booklet is mandated by statute, regulation or by a governmental agency. Forms and publications do not include those that are written by outside authors that may be distributed by C.A.R.

LIST OF CONTENTS

RESIDENTIAL ENVIRONMENTAL HAZARDS: A Guide for Homeowners, Homebuyers, Landlords and Tenants

Protect Your Family From Lead In Your Home

The California Home Energy Rating System (HERS)

The Homeowner's Guide to Earthquake Safety (includes gas shut-off valve update)

CALIFORNIA ENVIRONMENTAL PROTECTION AGENCY

RESIDENTIAL ENVIRONMENTAL HAZARDS: *A Guide For Homeowners, Homebuyers, Landlords and Tenants* 2011

This guide was originally developed by M. B. Gilbert Associates, under contract with the California Department of Real Estate in cooperation with the California Department of Health Services. The 2005 edition was prepared by the California Department of Toxic Substances Control, in cooperation with the California Air Resources Board and the California Department of Health Services, and meets all State and Federal guidelines and lead disclosure requirements pursuant to the Residential Lead-Based Paint Hazard Reduction Act of 1992. The 2005 edition incorporates the Federal "Protect Your Family from Lead" pamphlet. The 2011 update was developed California Department of Toxic Substances Control. This booklet is offered for information purposes only, not as a reflection of the position of the administration of the State of California.

Table of Contents

INTRODUCTION	3
CHAPTER I ASBESTOS	3
CHAPTER II CARBON MONOXIDE	10
CHAPTER III FORMALDEHYDE	13
CHAPTER IV HAZARDOUS WASTE	17
CHAPTER V HOUSEHOLD HAZARDOUS WASTE	21
CHAPTER VI LEAD	24
CHAPTER VII MOLD	31
CHAPTER VIII RADON	36
APPENDIX A LIST OF FEDERAL AND STATE AGENCIES	42
APPENDIX B GLOSSARY	46

Introduction

The California Departments of Real Estate and Health Services originally prepared this booklet in response to the California legislative mandate (Chapter 969, Statutes of 1989, AB 983, Bane) to inform the homeowner and prospective homeowner about environmental hazards located on and affecting residential property.

The 2005 edition was prepared by the California Department of Toxic Substances Control, in cooperation with the California Air Resources Board and the California Department of Health Services' Childhood Lead Poisoning Prevention Program, Radon Program, and Division of Drinking Water and Environmental Management, in response to a 1994 legislative mandate (Chapter 264, Statutes of 1994, AB 2753, Sher). The 1994 legislation also requires this booklet to consolidate the California disclosure requirements (Ch. 969, Statutes of 1989) and the federal disclosure requirements (The Residential Lead-Based Paint Hazard Reduction Act of 1992).

The information contained in this booklet is an overview of some environmental hazards which may be found on or in residential property and which may affect residential real estate. Since this booklet is not meant to be all inclusive, it should be used only for general guidance. Although law requires the disclosure of known hazards, an environmental survey may be conducted to obtain further information. Homeowners, tenants, and prospective homeowners may wish to obtain other literature for additional information on hazards of concern.

In California, sellers are required to disclose the presence of any known environmental hazard. A statement that the homeowner is unaware of environmental hazards is not a guarantee that the property is free of such hazards. It is in the homeowner's and prospective homeowner's interest to know what hazards are common, where they are found, and how they might be mitigated. This booklet will provide homeowners and prospective homeowners with the information and additional resources needed to make an informed decision about environmental hazards that may be present on a property.

Because of the contribution of household hazardous wastes to the problem of hazardous waste disposal, a section on proper storage and disposal of household hazardous products is included. In discussing health impacts of hazardous substances, lifetime exposure to low levels is emphasized because the resident is more likely to encounter this type of exposure than exposure to high levels of hazards for a short time. Sources of additional information and a list of government agencies are provided for further information.

Pursuant to AB 983, if this environmental hazards booklet is made available to homeowners or prospective homeowners, real estate licensees and home sellers are not required to provide additional information on such hazards. However, delivery of this publication to homeowners or prospective homeowners does not relieve home sellers

and real estate licensees of the responsibility to disclose the existence of environmental hazards when such hazards are known to them.

The material is presented with the understanding that the publisher is not engaged in offering legal or other professional advice. If legal or other expert assistance is required, the services of a skilled professional should be obtained.

CHAPTER I ASBESTOS

What is Asbestos?

Asbestos is the name given to a number of naturally occurring fibrous silicate minerals that have been mined for their useful properties such as thermal insulation, chemical and thermal stability, and high tensile strength. The three common types of asbestos are chrysotile, amosite, and crocidolite. Chrysotile, also known as white asbestos and a member of the serpentine mineral group, is the most common. Asbestos can only be identified under a microscope.

Where is asbestos found in the home?

Asbestos has been used in many products found in the home that provide insulation, strength, and fire protection. In 1989, the U.S. Environmental Protection Agency (U.S. EPA) announced a phased ban of asbestos products to be completed by 1996. However, in 1991, the U.S. Fifth Circuit Court of Appeals overturned and remanded the asbestos ban and phase-out rule to EPA. Today, most asbestos products can still be legally manufactured, although production of asbestos containing materials has decreased dramatically since the late 1970s. The most common items in the home that may contain asbestos are:

- Vinyl flooring
- Duct wrapping on heating and air conditioning systems
- Insulation on hot water pipes and boilers
- Some roofing shingles, and siding
- Vermiculite attic insulation
- Ceiling and wall insulation
- Sheet rock taping compounds and some ceiling materials

Asbestos that has been sprayed on ceilings often has a spongy, “cottage cheese” appearance with irregular soft surfaces. Asbestos troweled on walls has a textured, firm appearance. Vermiculite attic insulation, found both in the attic between trusses and in-between walls, also has the potential to contain asbestos. Vermiculite attic insulation is a pebble-like, pour-in product and is usually light-brown or gold in color.

Manufacturers can provide information on the asbestos content of home products. A certified asbestos consultant can be hired to test building material and determine whether or not asbestos is present and to give advice about how to take care of it safely. Current asbestos bulk testing methods may be insufficient to determine the presence of asbestos in vermiculite attic insulation. For more information on vermiculite, see U.S. EPA’s Protect Your Family from Asbestos-Contaminated Vermiculite at www.epa.gov/asbestos/pubs/verm_questions.html.

How is asbestos harmful?

Intact or sealed (painted or taped over) asbestos is not harmful unless it becomes damaged and friable. Friable means the material can be easily crushed or pulverized to a powder by hand pressure. Friable materials have a higher potential to release fibers. Asbestos fibers that are released into the air and inhaled can accumulate in the lungs and pose a health risk. This risk can be divided into two general categories: risk of asbestosis (lung scarring); and increased risk of cancer.

The U.S. EPA classifies asbestos as a known human carcinogen. If asbestos fibers are inhaled, the chance of contracting lung cancer or mesothelioma (cancer of the lining of the chest or abdomen) increases. The more asbestos is inhaled, the greater risk of developing cancer. Smokers who are exposed to high levels of asbestos have a much greater risk of developing lung cancer than nonsmokers exposed to the same level. Symptoms of cancer may not develop until 10-40 years after the first exposure to asbestos.

Is there a safe level of asbestos?

There is no safe level of asbestos exposure. The more asbestos fibers you inhale, the greater your risk of developing lung cancer and asbestos-related disease. Exposure to asbestos should always be avoided.

How can asbestos content in materials be determined?

When you suspect asbestos is present in building materials, it is important to have the materials tested by a qualified laboratory. Visual inspection alone is not enough to identify the presence of asbestos. It is recommended that you contact a certified asbestos consultant to take samples of potential asbestos containing materials and have them tested by a qualified laboratory. A list of asbestos consultants who have been certified by the California Department of Industrial Relations, Division of Occupational Safety and Health (Cal/OSHA) for evaluating building materials and recommending a course of action may be obtained on the Internet at www.dir.ca.gov/Databases/doshacru/acruList.asp or by calling 510-286-7362 .

How should the homeowner repair or remove asbestos?

Repair or removal of asbestos by the homeowner may be unwise if the damage is severe, since it may result in unnecessary exposure to airborne fibers. In cases where planned remodeling projects are expected to damage asbestos-containing materials, it is wise to hire a qualified contractor to remove the material. The homeowner should use the following guidelines in choosing a qualified contractor:

- Check to see if the contractor is licensed by the California Contractors State License Board and registered with the California Department of Industrial

Relations, Division of Occupational Safety and Health (Cal/OSHA) for doing asbestos work.

- Be aware that some contractors may remove material incorrectly and still charge a substantial fee.
- Require references from the contractor and check them to see if the contractor's work is satisfactory.
- Require the contractor to specify his safety procedures in writing.

The homeowner can expect to pay three times as much for a small removal job than a large one as it is expensive for a contractor to set up all the necessary safety equipment. You should consider hiring a certified asbestos consultant to review safety procedures and oversee the performance of the contractor.

Does the law require asbestos mitigation?

Asbestos mitigation is at the discretion of the homeowner. Even if material contains asbestos, the homeowner may choose to leave it alone or, if necessary, repair it. If the home owner chooses to do his or her own repairs, the home owner must comply with the law. The free Department of Toxic Substances Control fact sheet "Managing Asbestos Waste" is available on the DTSC Web site at www.dtsc.ca.gov/PublicationsForms/upload/OAD_FS_Asbestos1.pdf

What about naturally occurring asbestos that is found near the home?

Naturally Occurring Asbestos (NOA) includes six regulated naturally occurring minerals (actinolite, amosite, anthophyllite, chrysotile, crocidolite, and tremolite) and is commonly found in California within serpentine and other ultramafic rocks and soils of the Coastal Ranges, Klamath Mountains, and the Sierra Nevada Mountains. The California Geological Survey has produced a map that identifies areas more likely to contain NOA in California. The map may be found online at www.consrv.ca.gov/cgs/minerals/hazardous_minerals/asbestos/index.htm.

Asbestos fibers may be released into the air as a result of activities which disturb NOA-containing rock or soils. Development construction activities in areas that contain NOA may release asbestos. Also, driving on roads or driveways surfaced with asbestos containing gravel, such as serpentine, may release asbestos. The California Air Resources Board (ARB) has established Asbestos Airborne Toxic Control Measures (ATCMs) to regulate the surfacing of roads with asbestos-containing gravels and construction and grading activities in areas potentially containing asbestos. For more information about naturally occurring asbestos, go to www.arb.ca.gov/toxics/asbestos/asbestos.htm.

Hotlines:

For information on the identification and abatement of asbestos hazards in the home, and other information about asbestos visit the U.S. EPA Asbestos Web site at www.epa.gov/asbestos .

For technical assistance and information about:

- Toxic Substances Control Act (TSCA);
- Regulations and programs administered under TSCA, including asbestos, lead-based paint, and PCB's; and
- EPA's 33/60 voluntary pollution prevention program;

Contact the Toxic Substances Control Act Assistance Information Service (T.A.I.S.), Washington, D.C. at:

Telephone: (202) 554-1404
Fax: (202) 554-560
E-mail: tsca-hotline@epa.gov

Publications:

Indoor Air Quality Infosheet - Asbestos

This free publication is available from:

American Lung Association
Environmental Health Department
909 12th Street
Sacramento, CA 95814
Telephone: (800) LUNG-USA [(800) 586-4872]

***The Inside Story - A Guide to Indoor Air Quality
Asbestos in Your Home***

These free publications are available from:

U.S. EPA Indoor Air Quality Information Clearinghouse
P.O. Box 37133
Washington, D.C. 20013-7133
Telephone: (800) 438-4318
FAX: (202) 484-1510
E-mail: iaqinfo@aol.com
Web: www.epa.gov/iaq

Asbestos in the Home and Workplace

This list is available on the Internet from:
California Department of Health Services
Indoor Air Quality Program

http://www.cdph.ca.gov/programs/IAQ/Documents/IAQ_Asbestos_2000-03.pdf

List of Certified Asbestos Consultants

This list is available on the Internet or by mail for \$8.00 from:

California Department of Industrial Relations
Division of Occupational Safety and Health (Cal/OSHA)
Asbestos Consultant Certification Unit
2211 Park Towne Circle, Suite 1
Sacramento, CA 95825
Telephone: (916) 574-2993
Web: www.dir.ca.gov

List of Asbestos Abatement Contractors

This list is available for \$25.00 from:

California Department of Industrial Relations
Division of Occupational Safety and Health (Cal/OSHA)
Asbestos Contractor Registration Unit
455 Golden Gate Avenue, 10th Floor
San Francisco, CA 94102
Telephone: (415) 703-5190
Web: www.dir.ca.gov

What You Should Know Before You Hire a Contractor

This free publication is available from:

California Contractors State License Board
9835 Goethe Road
P.O. Box 26000
Sacramento, CA 95827
Telephone: (800) 321-2752 (To receive the publication, leave your name and address on message phone.)

Note: Telephone numbers and prices were correct at the date of publication of this booklet, but are subject to change.

CHAPTER II CARBON MONOXIDE

What is carbon monoxide?

Carbon Monoxide (CO) is an odorless, colorless and tasteless gas. It is highly toxic to humans and animals in higher quantities.

Because it is impossible to see, taste or smell, breathing CO can incapacitate or kill you before you are aware it is present in your home. At lower concentrations, CO may produce flu-like symptoms, including headache, dizziness, disorientation, nausea and fatigue.

What are the sources of carbon monoxide in the home?

CO is the result of incomplete combustion of carbon fuels and is produced from both man-made and natural sources. Typical sources of CO in the home are:

- Unvented kerosene and gas space heaters
- Gas water heaters
- Improperly adjusted or maintained furnaces or boilers
- Wood stoves and fireplaces
- Gas stoves and ovens
- Gasoline powered equipment, such as generators
- Automobile exhaust
- Tobacco smoke

How is carbon monoxide harmful?

Following inhalation, CO combines with hemoglobin in the blood producing carboxyhemoglobin, which is ineffective in delivering oxygen to the body tissues. Carbon monoxide binds to other molecules such as myoglobin and mitochondrial cytochrome oxidase and may cause significant damage to the heart and central nervous system.

At low concentrations, CO exposure may result in fatigue in healthy individuals and chest pain in people with heart disease. At higher concentrations, CO may result in headache, nausea, dizziness, confusion, impaired vision, angina and reduced brain function, depending upon the concentration in air and length of exposure. Exposure to very high concentrations of CO can be fatal.

Breathing high levels of CO during pregnancy may result in miscarriage. Breathing moderate levels of CO during pregnancy can result in slower than normal mental development of your child. In animal studies, exposure to CO during pregnancy had

effects on birth weight, the heart, the central nervous system and development. Children with asthma may be more susceptible to respiratory effects following exposure to CO.

What levels of carbon monoxide are found in the home?

Typical levels in homes with no gas appliances range from 0.5 to 5 parts per million (ppm). Levels measured near properly adjusted gas appliances were between 5 and 15 ppm, while levels near poorly adjusted appliances can be 30 ppm or higher.

Is there a safe level of carbon monoxide?

No standards for CO have been adopted for indoor air. The National Ambient Air Quality Standards for outdoor air are 9 ppm for eight hours and 35 ppm for one hour. The State of California Air Resources Board (ARB) air quality standards for CO are 9 ppm for eight hours and 20 ppm for one hour. The State of California, Office of Environmental Health Hazard Assessment (OEHHA) established an acute, one hour exposure level of 23,000 micrograms per cubic meter of air ($\mu\text{g}/\text{m}^3$) or 20 ppm for CO. This exposure level was based on heart toxicity.

Can carbon monoxide be detected and measured?

California Senate Bill 183 (SB 183) will require owners of single family homes that have a fossil-fuel burning appliance, fireplace or attached garage to install a CO alarm(s) by July 1, 2011. CO detectors trigger an alarm based on accumulation of CO over time or continuous detection of CO.

What can be done to reduce exposure to carbon monoxide?

Always make sure that gas appliances are maintained and properly installed. Here are some common tips to reduce potential CO levels in your home:

- Make sure appliances that burn natural gas, kerosene or other fuels are properly installed and vented.
- Have all appliances maintained on a regular basis.
- Always follow the manufacturer's recommendations and instructions for installation of these devices.
- Do not use portable gas heaters in enclosed indoor settings.
- Do not let your car idle for long periods of time inside the garage.
- Install and use an exhaust fan vented to the outside over gas stoves.
- Make sure the flue is open when using your fireplace.
- Use properly sized wood stoves certified to meet emission standards.
- Most importantly, install carbon monoxide detectors throughout the home.

Links to Additional Information on Carbon Monoxide:

U.S. EPA, An Introduction to Indoor Air Quality (IAQ), Basic Information on Pollutants and Sources of Indoor Air Pollution, Carbon Monoxide,
www.epa.gov/iaq/co.html

OEHHA, Impacts of Criteria Air Pollutants on the Respiratory Health of Children
www.oehha.ca.gov/public_info/public/kids/pdf/balmes.pdf

USFA, DHS, Exposing an Invisible Killer: The Dangers of Carbon Monoxide
www.usfa.dhs.gov/citizens/co/fswy17.shtm

Centers for Disease Control and Prevention (CDC), Carbon Monoxide Poisoning Fact Sheet
www.cdc.gov/co/faqs.htm

Agency for Toxic Substances Disease Registry, CDC, ToxFAQs for Carbon Monoxide
www.atsdr.cdc.gov/toxfags/tf.asp?id=1163&tid=25

American Lung Association, Carbon Monoxide Indoors
www.lungusa.org/healthy-air/home/resources/carbon-monoxide-indoors.html

US Consumer Product Safety Commission (CPSC), Carbon Monoxide Questions and Answers
www.cpsc.gov/cpsc/pub/pubs/466.html

CHAPTER III FORMALDEHYDE

What is formaldehyde?

Formaldehyde is a colorless, pungent gas that is soluble in water and most organic solvents. It is used as a raw material in the manufacture of building materials, many consumer products, and some fabrics. Formaldehyde is found in the outdoor air at an average concentration of approximately 3 parts per billion (ppb) or 3.7 micrograms per cubic meter of air ($\mu\text{g}/\text{m}^3$).

How is formaldehyde harmful?

The Office of Environmental Health Hazard Assessment (OEHHA) has concluded that exposures to formaldehyde can cause cancer in humans. In 2004, the International Agency for Cancer Research upgraded formaldehyde to a Group I (known human) carcinogen, based on human epidemiology studies of nasopharyngeal cancer. Exposure to airborne formaldehyde may also cause other illnesses, such as irritation to the eyes, skin, and respiratory tract; coughing; sore or burning throat; nausea; and headaches. Formaldehyde may also worsen asthma or allergy symptoms in those with such pre-existing sensitivities. Reducing exposures to formaldehyde will reduce these health risks.

What levels of formaldehyde are found in the home?

The average formaldehyde concentration inside California homes is about 14 ppb ($17 \mu\text{g}/\text{m}^3$) in conventional homes and 37 ppb ($45 \mu\text{g}/\text{m}^3$) in manufactured homes. Formaldehyde concentrations have been measured at levels greater than 200 ppb ($246 \mu\text{g}/\text{m}^3$) in both manufactured and new conventional homes. However, concentrations inside manufactured homes are generally higher than those in conventional homes due to the increased use of composite wood products.

What are the sources of formaldehyde in the home?

Indoor sources are the major cause of exposures to formaldehyde because people spend most of their time indoors, and there are many indoor sources of formaldehyde that typically produce concentrations several times higher than outdoor levels. Composite wood products are probably the greatest source of formaldehyde in the home. Other sources include other building materials such as some paints, coatings, and wallpaper; some consumer products such as fingernail products; permanent pressed fabric such as clothing and draperies; and combustion sources such as cigarettes and gas appliances.

What are composite wood products?

Plywood, particleboard, and oriented strandboard are composite wood products that are bound together with formaldehyde-containing resins. The two most commonly used resins are urea-formaldehyde and phenol-formaldehyde. Composite wood products used within the home include:

- Particleboard - used for cabinetry, subflooring, shelving, and furniture
- Hardwood plywood - used in paneling, furniture, and as a wall covering
- Medium density fiberboard - used in cabinets, doors, table tops, furniture, and shelving
- Oriented strandboard and softwood plywood - used for exterior use and subflooring, which are manufactured using low-emitting phenol-formaldehyde resins

Why is formaldehyde emitted from these products?

In the production of the resins, not all formaldehyde is bound tightly. Unbound or free formaldehyde can be released later as a gas from composite wood products. Formaldehyde emissions are highest from products made with urea-formaldehyde resins and new products. Emissions ordinarily decrease to low levels over time, as the product ages and off-gasses. If properly manufactured, composite wood products that incorporate phenol-formaldehyde resins do not release significant amounts of formaldehyde.

Is urea-formaldehyde foam a significant source of formaldehyde in homes?

Urea-formaldehyde foam insulation (UFFI) was installed in the wall cavities of some homes during the 1970s and has been used in the manufacture of mobile homes. The Consumer Product Safety Commission banned the use of UFFI in homes and schools in 1982. Although a Federal Court subsequently removed this ban for procedural reasons, UFFI is not currently being installed in homes in California because it does not meet the insulation standards of the California Energy Commission. In homes where UFFI was installed prior to 1982, formaldehyde concentrations have declined with time to levels that are generally comparable to those in homes without UFFI.

How can formaldehyde be detected and measured?

Levels of formaldehyde can be measured by chemical analysis of air samples collected indoors. In general, ambient air monitoring of formaldehyde is done on a 24-hour or several day basis using standard analytical techniques and methods established by federal and state agencies. A useful indicator of the presence of indoor formaldehyde is knowledge of the formaldehyde content or emissions of products. This information can usually be obtained from the manufacturer. In general, you do not need to measure formaldehyde levels if there are few or no materials in the building known to emit high levels of formaldehyde, because levels would then be expected to approach the lower outdoor levels. However, if known or suspected sources are extensively present and cannot be readily removed, it is wise to measure the levels of formaldehyde, to assure that levels are no greater than 7 ppb ($9 \mu\text{g}/\text{m}^3$).

Is there a safe level of formaldehyde?

Most people experience eye and throat irritation when exposed to formaldehyde at levels above 100 ppb (123 µg/m³). Because people differ in their sensitivity to toxic effects, it is difficult to precisely define a concentration of formaldehyde that would be harmless to all people under all circumstances.

Levels in the outdoor air may be considered as the lowest levels that can practicably be achieved in the home. OEHHA has established acute (55 µg/m³, or 44 ppb, one-hour average) and chronic (9 µg/m³, or 7 ppb, long-term average) exposure levels to identify the levels at which sensitive individuals might experience adverse non-cancer health effects. For indoor environments, OEHHA has also identified 7 ppb as the eight hour average level that is protective against non-cancer effects for sensitive individuals. Because formaldehyde may cause cancer, and there is no known level that is absolutely risk free, the California Air Resources Board (ARB) recommends that indoor formaldehyde levels be reduced as much as possible.

What can be done to reduce indoor formaldehyde levels?

Immediate measures include opening windows to increase ventilation and reducing the number of new composite wood products in a home. Where possible, replace composite wood products such as bookcases with products made from solid wood or non-wood materials. Formaldehyde emissions increase with increasing humidity and temperature. Therefore, reducing the temperature and humidity in the home will reduce formaldehyde levels.

Where the source of formaldehyde is wood paneling or extensive cabinetry, these measures may not be adequate. In those cases, removal of the paneling or coating, or replacement of cabinets may be necessary. Local trade organizations and builders' associations may be helpful in finding a contractor to do this work. You can find additional suggestions for reducing indoor formaldehyde levels in the publications listed below.

Publications:

Formaldehyde in the Home-Indoor Air Quality Guideline #1, updated August 2004, www.arb.ca.gov/research/indoor/guidelines.htm

OEHHA, Appendix D. Individual Acute, 8-Hour, and Chronic Reference Exposure Level Summaries, December 2008, www.oehha.ca.gov/air/hot_spots/2008/AppendixD1_final.pdf#page=128

Determination of Formaldehyde and Toluene Diisocyanate Emissions from Indoor Residential Sources, www.arb.ca.gov/research/apr/past/indoor.htm , click on Toxic Air Contaminants, scroll down.

Final Report on the Identification of Formaldehyde as a Toxic Air Contaminant - 1992.

These free publications are available from:
California Air Resources Board, Research Division, Indoor Exposure Assessment
Section
P.O. Box 2815
Sacramento, CA 95812
Telephone: (916) 322-8282 (For first two publications listed)
Telephone: (916) 322-7072 (For third publication listed)
Web: www.arb.ca.gov

***The Inside Story - A Guide to Indoor Air Quality
An Update on Formaldehyde***

These free publications are available from:
Indoor Air Quality Information Clearinghouse
P.O. Box 37133
Washington, D.C. 20013-7133
Telephone: (800) 438-4318
FAX: (202) 484-1510
E-mail: iaqinfo@aol.com
Web: www.epa.gov/iaq/

***A Consumers Guide to Manufactured Housing
Manufactured Housing for Families***

These free publications are available from:
California Department of Housing and Community Development
Division of Administration
P.O. Box 31
Sacramento, CA 95812-0031
Telephone: (916) 445-3338
Web: www.hcd.ca.gov

Note: Telephone numbers and prices were correct at the date of publication of this booklet, but are subject to change.

CHAPTER IV HAZARDOUS WASTE

What is hazardous waste?

Hazardous waste is anything left over from a manufacturing process, chemical laboratory, or a commercial product that is dangerous and could hurt people, animals, or the environment. Many industries, such as oil and gas, petrochemical, electronics, dry cleaners, and print shops, generate hazardous waste.

When hazardous waste is properly managed it is shipped to special facilities for treatment, storage, disposal, or recycling. Hazardous waste that is not properly managed may escape into the environment and contaminate the soil, surface and ground water, or pollute the air. Some causes of hazardous waste releases are leaking underground storage tanks, poorly contained landfills or ponds, hazardous waste spills, or illegal dumping directly on land or water.

What is California doing to locate and clean up hazardous waste sites?

The U.S. EPA has targeted about 1,200 sites nationwide for federal cleanup under the federal Superfund Program. Almost 100 of those sites are in California. California is overseeing the cleanup of hundreds of other sites under a state Superfund administered by the California Department of Toxic Substances Control (DTSC). DTSC works jointly with U.S. EPA and other state agencies, such as the California Regional Water Quality Control Boards and local health departments, to manage hazardous waste problems. The primary purpose of site cleanup and mitigation activities at hazardous waste sites is to reduce or eliminate the risks the sites pose to public health or the environment.

How can the prospective homeowner determine if a home is affected by a hazardous waste site?

State law requires certain written disclosures to be made to prospective homeowners. The seller is required to disclose whether he or she is aware that the property has any environmental hazards such as asbestos, formaldehyde, radon, lead-based paint, fuel or chemical storage tanks, or contaminated soil or water. You can find additional information on real estate disclosure "Disclosures in Real Property Transactions" available from the California Department of Real Estate. See Appendix A in this document for information on how to contact them.

A prospective homeowner may also get information about hazardous waste sites near a home by consulting the "Hazardous Waste and Substances Sites List" which is maintained by the California Environmental Protection Agency (CalEPA). The list is a comprehensive inventory of hazardous waste sites in California, including contaminated wells, leaking underground storage tanks, and sanitary landfills from which there is a known migration of hazardous waste. It also lists active federal and state hazardous waste sites scheduled for cleanup as well as potential hazardous waste sites.

Information on how you can get a copy of this list is at the end of this chapter. The addresses of federal and state agencies that manage hazardous waste programs are listed in Appendix A.

A homeowner or prospective homeowner may choose to hire a registered environmental assessor to investigate a known or suspected environmental hazard at a property. To obtain a list of registered environmental assessors, contact the Registered Environmental Assessor Program at:

P.O. Box 806
Sacramento, CA 95812-0806
Telephone: (916) 324-6881
FAX (916) 324-1379
Web: www.dtsc.ca.gov/rea/

Internet Resources:

You can learn more about the role of the Department of Toxic Substances Control in protecting Californians from hazardous waste by visiting its Web site at

www.dtsc.ca.gov .

Department of Toxic Substances Control Envirostor Database can be accessed at

<http://www.envirostor.dtsc.ca.gov/public/>.

The Federal database of potentially contaminated sites is available at

www.epa.gov/superfund/sites/index.htm.

The Hazardous Waste and Substances Sites List (Cortese List) on the locations of hazardous materials release sites is at

www.dtsc.ca.gov/database/Calsites/Cortese_List.cfm .

The List of Leaking Underground Storage Tanks is available on the Web at

www.geotracker.waterboards.ca.gov.

Hotlines:

For information on the federal Superfund program and the National Priorities List (NPL), contact the U.S. EPA RCRA, Superfund, EPCRA hotline at:

Telephone: (800) 424-9346

Publications:

Disclosures in Real Property Transactions

This publication is available for \$2.00 plus tax from:

California Department of Real Estate Book Orders

P.O. Box 187006

Sacramento, CA 95818-7006 (Mail orders only; a self-addressed envelope is required.)

Web: http://www.dre.ca.gov/pdf_docs/re6.pdf

List of Registered Environmental Assessors

This list is free if you are hiring a registered environmental assessor. If you wish to use it as a mailing list, it is available on CD for \$6.25 and as a hard-copy printout for \$35.00. It's also available free on our Web site at:

www.dtsc.ca.gov/rea

Department of Toxic Substances Control
Registered Environmental Assessor Program
P.O. Box 806
Sacramento, CA 95812-0806
Telephone: (916) 324-6881

The Toxics Directory: References and Resources on the Health Effects of Toxic Substances

This publication is available for \$9.90 from:
California Department of General Services
Documents and Publications
P.O. Box 1015

North Highlands, CA 95660

(Send written request with your name and street address. Make your check out to *Procurement Publications*.)

Ensuring Safe Drinking Water (600M91012)

This free publication is available from:
U.S. Environmental Protection Agency
Public Information Center
1200 Pennsylvania Ave, N.W.
Washington, D.C. 20460
Telephone: (800) 490-9198

Consumer's Guide to California Drinking Water

This publication is available for \$4.00 (plus 5% shipping charge and tax) from:

Local Government Commission
1414 K Street, Suite #600
Sacramento, CA 95814
Telephone: (916) 448-1198 x307
Web: www.lgc.org

Is Your Drinking Water Safe? (PB94-203387)

This publication is available for \$19.50 plus \$4.00 shipping from:

National Technical Information Service
5285 Port Royal Road
Springfield, VA 22161
Telephone: (800) 553-6847
Web: www.ntis.gov

Note: Telephone numbers and prices were correct at the date of publication of this booklet, but are subject to change.

CHAPTER V HOUSEHOLD HAZARDOUS WASTE

What is household hazardous waste?

Although hazardous waste is usually associated with industrial or manufacturing processes, each year Californians discard tons of hazardous wastes in trash cans or down the drain. To determine whether a product is hazardous, ask yourself these questions:

- Is it poisonous when swallowed, touched, or inhaled?
- Does it catch fire easily?
- Is it corrosive? Can it eat through certain containers?
- Is it reactive? Could it explode if it is improperly stored, spilled, or mixed with other products?

If you answer yes to any these questions, then the product is hazardous. Information about whether a product is hazardous usually can be found on the container label. The words “caustic,” “flammable,” “toxic,” and “ignitable” mean that the product is hazardous.

Some products are hazardous on their own, but can become even more dangerous when they are mixed with other household products. For example, most people know that bleach is poisonous, but when it is mixed with ammonia-based cleaners it releases chlorine and hydrazine gases, both of which are extremely poisonous.

Some other hazardous household products are:

- Cleaning products containing ammonia
- Chlorine bleach and cleaning products containing it
- Drain cleaners
- Carpet cleaning products
- Oven cleaners
- Metal polishes
- Garden supplies such as weed and insect killers, rat poison, and fertilizer
- Charcoal lighter fluid, and kerosene
- Automotive supplies such as antifreeze, motor oil, gasoline, batteries and brake fluid
- Paint, varnish, paint removers, glues, and waxes
- Electronic products such as cathode ray tubes, televisions, computers, cell phones
- Universal wastes such as fluorescent lights, small batteries, and products containing mercury

How should hazardous household products be stored?

Hazardous products should be stored in a cool, dry, secure location. They should be stored in locked cupboards, locked drawers, or on a high shelf out of the reach of children and pets. To prevent hazardous products from spilling during an earthquake, shelves should be firmly secured to the wall and have a restraining bar along the side.

The following guidelines will help you properly store household hazardous products:

- Store poisonous products apart from other products.
- Sort products into hazardous waste categories of poisonous, flammable, corrosive, and reactive and store them separately. For example, flammable products such as charcoal lighter and waste oil should be stored apart from corrosive products such as drain cleaner and acid batteries. It is important to store reactive products in a separate location.
- Store bleach and ammonia-based cleaners in separate cupboards, so that if there is a spill the products won't get mixed and release poisonous gas.
- Store products in their original containers.
- Make sure labels can be read and won't come off the container.
- Tightly seal containers and check them often to make sure they are not breaking down. If you notice a container is rusting or leaking, put it inside a larger container and label it clearly.

What is the best way to dispose of household hazardous waste?

The best way to dispose of household hazardous waste is to take it to a community household hazardous waste collection center in your area.

You should never pour unused hazardous household products down the drain. That is illegal in California. It is also illegal to pour used oil and paints on land, down drains, including the storm drains, or to burn them. Waste motor oil, oil filters, antifreeze, and used batteries can be recycled. You should take them to a recycling center or a household hazardous waste collection center. For information about recycling specific products or about household hazardous waste collection programs in your community, call 1-800-CLEANUP or visit the

Department of Resources Recycling and Recovery (CalRecycle) Web site at <http://www.calrecycle.ca.gov/>. You can get additional information on household hazardous waste at www.earth911.org.

Hotlines:

For information on household hazardous waste and used oil collection and recycling centers, information on buying recycled products, the 3 R's - Reduce, Reuse and Recycle, and other environmental tips and events, contact the California Environmental Hotline at:

Telephone: 1-800-CLEANUP (1-800-253-2687)

Web Site: www.1800cleanup.org

*For information on recycling and collection centers and referrals for county and city agencies, call the California Integrated Waste Management Board at:
Telephone: (800) 553-2962*

*To report hazardous waste violations, call the California Department of Toxic Substances Control Waste Alert hotline at:
Telephone: (800)-69TOXIC [(800) 698-6942]*

*For general information on hazardous wastes, call the California Department of Toxic Substances Control at:
Telephone: (800) 61TOXIC [(800) 618-6942]*

Publications:

Household Products Management Wheel

This product is available for \$4.95 from:
Environmental Hazards Management
Institute 10 New Market Road
P.O. Box 932
Durham, NH 03824
Telephone: (603) 868-1496
FAX: (603) 868-1547

Note: Telephone numbers and prices were correct at the date of publication of this booklet, but are subject to change.

CHAPTER VI LEAD

How is lead harmful?

Lead is a common environmental toxin that has been used extensively in consumer products such as paint and gasoline. Much of that lead remains in the California environment where people may be exposed to it. Children under the age of six years are particularly at risk. They typically are exposed to lead through the normal hand-to-mouth behavior that occurs as they explore their environment. Crawling or playing on the floor, and putting their fingers, toys, and other items in their mouths can expose a child to lead. Lead poisoning, which is often unrecognized, can result in health effects that are often irreversible, including brain damage, mental retardation, convulsions, and even death. If lead poisoning goes undetected, it may result in behavior problems, reduced intelligence, anemia, and serious liver or kidney damage.

Lead is also harmful to adults. Lead poisoning can cause reproductive problems in both men and women, high blood pressure, kidney disease, digestive problems, nerve disorders, memory and concentration problems, and muscle and joint pain. Adult lead poisoning is most often the result of occupational exposure, or exposure following unsafe home renovation. If a pregnant woman is lead poisoned, the lead can pass into her baby's blood and poison the baby.

How can I find out if my family has lead poisoning?

The most important step you can take to protect your children is to prevent them from being exposed to lead. Most lead poisoning does not cause acute symptoms, so the only way to know if a person is lead poisoned is by testing the level of lead in his or her blood.

There are many ways a child can be exposed to lead. The law assumes that, at minimum, children are at risk if they are on publicly funded programs for low-income children or if they live in, or spend a lot of time in, a place built before 1978 that has peeling or chipped paint, or that has been recently renovated. These children must be tested for lead at age one and two years. Children below the age of six years, who were not tested at ages one or two, should receive make-up testing as soon as possible. If you have a job or a hobby where you may be exposed to lead, you should be tested regularly. If you are pregnant, ask your doctor about a lead test.

A physician can order this simple test. Some doctors and healthcare centers can perform the test in their offices. Under California law, it must be covered by health insurance plans. Children from families with modest incomes can be tested at no cost through the Child Health and Disability Prevention Program (CHDP). The test is a required part of well-child checkups. For more information on CHDP and to locate an office in your area visit their Web site at www.dhs.ca.gov/pcfh/cms/chdp.

Because lead poisoning is the result of contact with lead, the primary treatment is to identify the source of lead, and remove or isolate it. Further medical management may be necessary, depending on factors such as the severity and duration of exposure. Adults and children who become lead poisoned will need regular testing to monitor levels of lead in the body.

Where is lead found in the home?

Many houses and apartments built before 1978 have paint that contains lead. In 1978, the Consumer Product Safety Commission banned paint containing high levels of lead for residential use. If your home or apartment was built before 1978, you should assume it has lead paint.

Lead-based paint that is peeling, chipping, chalking, or cracking is a hazard and needs immediate attention. Lead-based paint may also pose a hazard on surfaces children can chew or in areas with heavy wear. These areas include windows, windowsills, doors and doorframes, stairs, railings, banisters, porches, and fences. When painted surfaces bump or rub together, they generate lead dust. Likewise, dry-scraping, sanding, or heating lead paint during repainting or remodeling also creates large amounts of lead dust. This dust can poison your family.

Soil may be contaminated with lead from leaded gasoline emissions and from deteriorating exterior paint. Lead in soil can be a hazard to children who play in the bare soil. It can also contaminate the home and floor dust when people track soil into the house on their shoes.

Other Sources: Lead can be found in jobs such as battery repair or recycling, radiator repair, painting or remodeling, and lead smelting. Lead from the workplace poses a hazard for workers' families. Workers can bring lead into their homes on their work clothes, shoes, and bodies without knowing it. Some hobbies also use lead. These include ceramics, stained glass, fishing weights, and bullet casting or firing. Lead can leach into food cooked, stored, or served in some imported dishes or handmade pottery. Some traditional remedies such as Azarcon, Greta, Pay-loo-ah, Surma, Kohl, and Kandou contain large amounts of lead and present a serious danger. Imported candy, especially chili or tamarind candy or its packaging, is frequently lead contaminated. Lead has been found in painted toys and inexpensive costume jewelry, particularly imported items. Older water systems may have pipes containing lead or pipes with lead solder.

How can I check my home for lead hazards?

To inspect your home for lead hazards, hire an individual who has been certified by the California Department of Public Health (CDPH). CDPH certification is now required for all those doing lead hazard evaluations, lead abatement plan preparation, lead abatement work and lead clearance inspections for residential and public buildings in California ([Title 17, CCR § 35001-35050 and § 36000-36100](#)). A CDPH-certified

inspector/assessor can determine the lead content of painted surfaces in your home and identify sources of lead exposure such as peeling paint, lead contaminated soil, or lead-contaminated dust. The assessment should outline the actions to take to address these hazards.

A CDPH-certified inspector/assessor may use a variety of methods to assess lead hazards in your home. These include visual inspection of paint condition; laboratory tests of paint, dust and soil samples; and a portable x-ray fluorescence lead testing (XRF) machine.

You may have seen home lead test kits in your local hardware store. Recent studies suggest, however, that they are not accurate for testing paint, soil, or dust. They may be used, however, to test pottery and ceramics for the presence of lead.

How can I reduce lead hazards safely?

If your house has lead hazards, you can take action to reduce your family's risk. Most importantly, if you have young children, be sure they receive a blood lead test. This is particularly critical if you live in a unit that has been recently renovated or have remodeled your home.

Second, keep your home as clean and free of dust and deteriorated paint chips as possible. Clean floors, window frames, windowsills, and other horizontal surfaces weekly. Use a mop, sponge, or disposable cloths with a solution of water and an all-purpose cleaner. Rinse out mops and sponges thoroughly after use. Use doormats or remove shoes before entering your home to avoid tracking in lead from bare soil. Have children play in grassy or landscaped areas instead of bare soil.

Wash children's hands often, especially before meals and bedtime. Keep play areas clean. Wash bottles, pacifiers, toys, and stuffed animals regularly. Feed your children nutritious meals that include foods high in iron and calcium. Give children regular meals and snacks. Children with full stomachs and nutritious diets tend to absorb less lead.

How can I significantly reduce lead hazards?

In addition to regular cleaning and good nutrition, you can **temporarily** reduce lead hazards by repairing damaged painted surfaces and planting grass or using landscaping materials to cover soil with high lead levels. These actions are not permanent solutions and need ongoing attention.

To **permanently** remove lead hazards, you should hire a lead abatement contractor. Abatement methods include removing, sealing, or enclosing lead-based paint with special materials. Simply painting over lead-based paint with regular paint is not a permanent solution. Hire an individual who has been certified by the CDPH as a Supervisor. CDPH-certified Supervisors and Workers have the proper training to do this

work safely. They have the proper equipment to clean up thoroughly. They will also follow strict safety rules set by the state and federal governments.

What precautions should I take when remodeling my home?

Before you begin any remodeling or renovations that will disturb painted surfaces, (such as scraping or sanding paint, or tearing out walls) test the area for lead-based paint. To fully protect your family from unsafe renovation hazards, hire a CDPH-certified Supervisor.

Never use a dry scraper, belt-sander, propane torch, or heat gun to remove lead-based paint. These actions create large amounts of poisonous lead dust and fumes. This lead dust can remain in your home long after the work is done, and can make your family very sick. It is important to move your family (especially children and pregnant women) out of the home until the work is completed and the area has been properly cleaned.

You can find out about other safety measures by calling (800) 424-LEAD [(800) 424-5323]. Ask for the brochure "Reducing Lead Hazards when Remodeling Your Home." This brochure explains what to do before, during, and after renovations.

What is the source of lead in water?

The source of lead in water is most likely to be lead in water pipes, lead solder used on copper pipes, and some brass plumbing fixtures. Lead pipes are generally found only in homes built before 1930. The use of lead-based solder in plumbing applications in homes and buildings was banned in 1988. However, many homes built prior to 1988 may contain plumbing systems that use lead solder. The levels of lead in water from these homes are likely to be highest during the first five years after construction. After five years there can be sufficient mineral deposit, except where the water is soft, to form a coating inside the pipe; this coating prevents the lead from dissolving. However, recently, new chemical agents being used in some water systems have been associated with increased corrosion and have resulted in increased levels of lead in water.

How can lead levels in water be determined?

If you suspect lead contamination in drinking water, you may submit water samples to a laboratory certified by the CDPH. For a list of certified laboratories, see Publications at the end of this chapter. Consult with the laboratory on the proper procedures for sample taking. Information on the possibility of lead contamination in your municipal water supply may be obtained from the water utility serving your area.

How can levels of lead in water be reduced?

Lead levels in water can be reduced by removing lead piping or lead solder, by installing a home treatment system certified by the CDPH, or regularly flushing each tap before consuming the water. Another alternative for homeowners is to purchase bottled water. A detailed discussion of home treatment systems is presented in, "Consumers Guide to California Drinking Water" (see Publications).

Where there are elevated lead levels in water, homeowners who choose not to install a treatment system, or use bottled drinking water, should flush each tap before the water is consumed. Water which has been standing in the water pipes for more than six hours should be flushed from the tap until the temperature changes, and then, for about 15 seconds more. Because lead is more soluble in hot water, the homeowner should not drink or prepare food using hot water from the tap. The flushed water should be saved and used for other purposes, such as washing clothes or watering plants.

What are my responsibilities if I am selling, renting, or remodeling a home built before 1978?

If you are planning to buy, rent, or renovate a home built before 1978, federal law requires sellers, landlords, and remodelers to disclose certain information prior to finalizing contracts.

Landlords must:

- Disclose known information on lead-based paint hazards.
- Give you a lead hazard pamphlet before leases take effect. Leases must also include a federal form about lead-based paint.

Sellers must:

- Disclose known information on lead-based paint hazards.
- Give you a lead hazard pamphlet before selling a house. Sales contracts must also include a federal form about lead-based paint. Buyers have up to 10 days to check for lead hazards.

Renovators must:

- Give you a lead hazard pamphlet before starting to work.

If you want more information on these requirements, call the National Lead Information Clearinghouse at (800) 424-LEAD [(800) 424-5323].

Hotlines:

*For more information on lead in drinking water and information on federal regulations about lead in drinking water, contact the U.S. EPA Safe Drinking Water Hotline in Washington, D.C. at:
Telephone: (800) 426-4791*

For information on how to protect children from lead poisoning, contact The National Lead Information Center at:

Telephone: (800) Lead-FYI [(800) 532-3394]

For other information on lead hazards, call The National Lead Information Center Clearinghouse at:

Telephone: (800) 424-LEAD [(800) 424-5323]

To request information on lead in consumer products, or to report an unsafe consumer product or a product-related injury, contact the Consumer Product Safety Commission at:

Telephone: (800) 638-2772

To request local lists of CDPH-certified inspectors or abatement workers, contact the Lead-related Construction Hotline at:

Telephone: (800) 597-LEAD [(800) 597-5323] or visit the CDPH Web site at www.cdph.ca.gov

To obtain additional information on lead poisoning, or a list of local county lead programs, contact the CDPH Childhood Lead Poisoning Prevention Branch at:

Telephone: (510) 620-5600 or visit the CDPH Web site at www.cdph.ca.gov/programs/CLPPB.

Publications:

List of Certified Laboratories to Perform Hazardous Waste Analysis

This free list is available from:

California Department of Health Services
Environmental Laboratory Accreditation Program
850 Marina Bay Parkway, Ste. G365/EHL
Richmond, CA 94804

Telephone: (510) 620-2800

Web: www.cdph.ca.gov/certlic/labs/Documents/ELAPLablist.xls

Guidelines for the Evaluation and Control of Lead-Based Paint Hazards in Housing

This publication is available for \$45.00 from:

Department of Housing and Urban Development (HUD)
Information Services, HUD User
P.O. Box 6091

Rockville, MD 20849

Telephone: (800) 245-2691

Web: www.huduser.org

Lead in your Drinking Water

This publication is available from:

U.S. Environmental Protection Agency
Public Information Center
1200 Pennsylvania Ave., N.W.
Washington, D.C. 20460
Telephone: (202) 272-0167

The Inside Story - A Guide to Indoor Air Quality

This free publication is available from:
Indoor Air Quality Information Clearinghouse
P.O. Box 37133
Washington, D.C. 20013-7133
Telephone: (800) 438-4318
Web: www.epa.gov/iaq/

Consumers Guide to California Drinking Water

This publication is available for \$4.00 (plus 5 percent shipping charge, and tax) from:
Local Government Commission
1414 K Street, Suite #250
Sacramento, CA 95814
Telephone: (916) 448-1198 x 307
Web: www.lgc.org

Lead Poisoning Prevention Wheel

This publication is available for \$3.95 from:
Environmental Hazards Management Institute
10 New Market Road
P.O. Box 932
Durham, NH 03824
Telephone: (603) 868-1496

Note: Telephone numbers and prices were correct at the date of publication of this booklet, but are subject to change.

CHAPTER VII MOLD

What are molds?

Molds are simple, microscopic organisms present virtually everywhere, indoors and outdoors. Molds, along with mushrooms and yeasts, are fungi and are needed to break down dead material and recycle nutrients in the environment.

For molds to grow and reproduce, they need only a food source – any organic material, such as leaves, wood, paper, or dirt – and moisture. Because molds grow by digesting organic material, they gradually destroy whatever they grow on. Sometimes, new molds grow on old mold colonies. Mold growth on surfaces can often be seen in the form of discoloration, frequently green, gray, brown, or black but also white and other colors. Molds release countless tiny, lightweight spores, which travel easily through the air.

How am I exposed to indoor molds?

Everyone is exposed to some mold on a daily basis without evident harm. There are usually mold spores in the air inside homes. Most indoor mold spores come from outdoors by blowing through open windows or being tracked into homes as dust on shoes. Mold spores primarily cause health problems when they are present in large numbers and people inhale high concentrations of spores in air. This can occur when there is active mold growth in a home, office, or school where people live or work. People can also be exposed to mold by touching moldy materials and by eating contaminated foods. Molds will grow and multiply whenever conditions are right, that is when sufficient moisture is available and organic material is present. The most important factor allowing mold to grow is dampness or moisture accumulation in the home. The following are common sources of indoor moisture that may lead to mold problems:

- Flooding
- Leaky roofs
- Sprinkler spray hitting the house
- Plumbing leaks
- Overflow from sinks, showers, bathtubs, or sewers
- Damp basement or crawl space
- Steam from bathing, doing laundry, or cooking
- Humidifier use
- Wet clothes drying indoors or clothes dryers exhausting hot, humid air indoors

Warping floors and discoloration of walls and ceilings can be indications of moisture problems. Condensation on windows or walls is also an important indication, but it can sometimes be caused by an indoor combustion problem. Have fuel-burning appliances routinely inspected by your local utility or a professional heating contractor.

Should I be concerned about mold in my home?

Yes, if indoor mold growth is extensive, it can cause very high and persistent airborne spore exposures. Persons exposed to high spore levels can become sensitized and develop allergies to the mold or other health problems. Mold growth can also damage your furnishings, such as carpets, sofas, and cabinets. Clothes and shoes in damp closets can become soiled. In time, unchecked mold growth can cause serious damage to the structure of your home.

What symptoms are commonly seen with mold exposure?

Exposure to large amounts of mold can cause health effects through inflammation, allergic response, or, rarely, infection. Allergic reactions, often referred to as hay fever, are the most common health problems reported following mold exposure. Typical symptoms that mold-exposed persons report, alone or in combination, include:

- Breathing problems, such as wheezing, difficulty breathing, and shortness of breath
- Nose or sinus congestion (stuffy feeling, sinus headache)
- Eye irritation (burning, watery, or reddened eyes)
- Dry, hacking cough
- Nose or throat irritation (runny nose, sneezing, sore throat)
- Skin rashes or red, itchy skin

Headaches, memory problems, mood swings, nosebleeds, body aches and pains, and fevers are occasionally reported in mold cases, but their cause is not understood.

How much mold can make me sick?

For some people, encountering even a relatively small number of mold spores can trigger an asthma attack or lead to other health problems. For other persons, symptoms may occur only when exposure levels are much higher. Nonetheless, indoor mold growth is unsanitary and undesirable. Basically, if you can see or smell mold inside your home, take steps to identify and eliminate the excess moisture and to cleanup and remove the mold.

Are some molds more hazardous than others?

Allergic persons have different levels of sensitivity to molds, both as to the amount and the types that cause them to feel ill. In addition to being able to cause allergies, certain types of molds, such as *Stachybotrys chartarum*, may produce compounds that have toxic properties, which are called mycotoxins. Mycotoxins are not always produced, and whether a mold produces mycotoxins while growing in a building depends on what the mold is growing on as well as environmental conditions such as temperature, humidity, and other unknown factors. When mycotoxins are present, they occur in both living and

dead mold spores and may be present in materials into which mold has grown. While *Stachybotrys chartarum* and some other types of molds are growing, a wet slime layer covers the spores, preventing them from becoming airborne. However, when the mold dies and dries up, air currents or physical handling can cause spores to become airborne.

At present there is no readily available, inexpensive test to determine if a mold growing in a building is producing toxins. A limited number of specialized laboratories can test for mycotoxins in dust or building materials such as gypsum wallboard. These tests are very expensive and the results are not helpful in determining if there is an additional health risk from mycotoxins. There are also no blood or urine tests that a physician can use to determine if an individual has been exposed to the spores of a toxin-producing fungus or its mycotoxins.

How can I tell if I have mold in my house?

You may suspect that you have mold if you see discolored patches or cottony or speckled growth on walls or furniture or if you smell an earthy or musty odor. You also may suspect mold contamination if mold-allergic individuals experience some of the symptoms listed earlier when in the house. Evidence of past or ongoing water damage should also trigger a more thorough inspection. You may find mold growth underneath water-damaged surfaces or behind walls, floors, or ceilings.

Should I test my home for mold?

The California Department of Public Health (CDPH) does not recommend testing as a first step to determine if you have a mold problem. Reliable air testing for mold can be expensive and requires experience and equipment that is not available to most people. Owners of individual private homes and apartments generally will need to pay a contractor to do such testing, because insurance companies and public health agencies seldom provide this service. Mold inspection and cleanup is usually considered a housekeeping task that is the responsibility of the homeowner or landlord, as are roof and plumbing repairs, house cleaning, and yard maintenance.

Another reason the CDPH does not recommend testing for mold is that there are few available standards for judging what is an acceptable amount of mold. In all locations, there is some level of airborne mold outdoors. If air testing is carried out in a home, an outdoor air sample also must be collected at the same time, to allow comparison of indoor and outdoor spore types and numbers. Because some people are much more sensitive to mold spores than are other people, mold testing is at best a general guide. The simplest way to deal with a suspicion of mold contamination is, if you can see or smell mold, you likely have a problem and should take the steps outlined below. Mold growth is likely to recur unless the source of moisture that is allowing mold to grow is removed and the contaminated area is cleaned.

Assessing the Size of a Mold Contamination Problem

There will be a significant difference in the cleaning recommendations for a small mold problem – total area of visible mold growth is less than 10 square feet – and a large mold problem – more than 100 square feet. In the case of a relatively small area, the homeowner using personal protective equipment, such as a dust mask, safety goggles, and household gloves, can handle the cleanup. However, for larger areas, choose an experienced, professional contractor.

General Cleanup Procedures

- Find and remove sources of moisture
- Find and determine the extent and area of visible mold growth
- Clean and dry moldy areas – do not allow dust from the moldy areas to get into the rest of the home
- Bag and dispose of all material that may have moldy residues, such as rags, paper, leaves, and debris

Clean up should begin after the moisture source is fixed and excess water has been removed. Wear gloves when handling moldy materials. **Spores are more easily released when moldy materials dry out, so it is advisable to remove moldy items as soon as possible.** Detailed cleanup procedures are available in the California Department of Health Services Indoor Air Quality Section fact sheet entitled, “Mold in My Home: What Do I Do?” It is available on the Internet at www.cdph.ca.gov/programs/IAQ/Documents/MIMH_2006-06_2009-03rev6p.doc or by calling (510) 620-2874.

How can I prevent indoor mold problems in my home?

Inspect your home regularly for signs and sources of indoor moisture and mold. Take steps to eliminate sources of water as quickly as possible. If a leak or flooding occurs, it is essential to act quickly so that wet materials can dry within 48 hours:

- Stop the source of the leak or flooding.
- Remove excess water with mops or wet vacuum.
- Move wet items to a dry, well-ventilated area. Move rugs and pull up wet carpet as soon as possible.
- Open closet and cabinet doors and move furniture away from walls to increase circulation.
- Run portable fans to increase air circulation. Do NOT use the home’s central blower if flooding has occurred in it or in any of the ducts. Do NOT use fans if mold may have already started to grow, or if it has been more than 48 hours since the flooding.
- Run dehumidifiers and window air conditioners to lower humidity.
- Do NOT turn up the heat or use heaters in confined areas, as higher temperatures may increase the rate of mold growth.

- If water has soaked inside the walls, it may be necessary to open wall cavities by removing the baseboards and drilling a hole through the bottom of the wet wall, or by prying away wall paneling.

Publications:

Mold in My Home: What Do I Do?

This free document is available from:
California Department of Public Health
Indoor Air Quality Section
850 Marina Bay Parkway, G365 EHLB
Richmond, CA 94804
Telephone: (510) 620-2874

Web: www.cdph.ca.gov/programs/IAQ/Documents/MIMH_2006-06_2009-03rev6p.doc

Numerous mold-related articles

and documents are available from:

California Department of Public Health
Environmental Health Investigation Branch
850 Marina Bay Parkway
Building P, 3rd floor
Richmond, CA 94804-6403

Web: www.ehib.org/search.jsp?ss=mold&google=on

Mold Remediation in Schools and Commercial Buildings
A Brief Guide to Mold, Moisture, and Your Home

These free documents are available from:

U.S. Environmental Protection Agency
IAQ Information Clearinghouse
Telephone: (800) 438-4318

Web: www.epa.gov/mold/moldresources.html

Repairing Your Flooded Home

This free publication is available from:

American Red Cross
8928 Volunteer Lane, Sacramento, CA 95826
Telephone: (916) 368-3131

Web: www.redcross.org

For local assistance, contact your county or city Department of Health, Housing, or Environmental Health. Phone numbers for these agencies are located in the blue government pages at the front of your local telephone directory.

Note: Telephone numbers and prices were correct at the date of publication of this booklet, but are subject to change.

CHAPTER VIII RADON

What is radon?

Radon is a naturally occurring colorless, tasteless, and odorless radioactive gas that comes from the decay of uranium found in nearly all soils. It enters buildings from the ground through cracks and openings in concrete slabs, crawl spaces, floor drains, sumps, and the many tiny pores in hollow-wall concrete blocks. When the pressure within a home is lowered, more radon can be drawn from the soil and enter the home. Indoor air pressure may be lower during colder months when heated air rises from the floor level to the ceiling or second story level in the house. Indoor pressure may also be lowered in tightly sealed houses through use of exhaust fans such as those in many kitchens and bathrooms.

Once inside a building, radon can become trapped. Unless the building is properly ventilated to remove it, the gas can become a health hazard.

Where is radon found?

Radon is typically present in rocks containing uranium such as certain granites and shales. The amount of radon that can enter soils and groundwater depends on the concentrations of uranium in the underlying rock. Radon can also be found in the air at very low concentrations.

If radon is present in tap water, it can be released when water is used indoors for showering, washing dishes, or washing clothes. Radon is of most concern when water is obtained directly from a well that draws water from a source exposed to uranium and radium. Most of the radon in water obtained from a surface source, such as a reservoir or well water stored in an open tank, has been released before it reaches the home. Building materials are not a significant source of radon except where they incorporate rocks rich in radium or uranium such as granite and shales.

Why is radon harmful?

Long-term exposure to elevated levels of radon can increase your risk of getting lung cancer. Tobacco smokers are at an even greater risk. Radon levels vary throughout the country. The amount of radon entering homes varies from home to home. Because radon is colorless, odorless, and tasteless, testing is the only way to find out if you and your family are at risk from it.

Exposure to radon does not result in any immediate symptoms. For example, it does not result in acute respiratory effects such as colds or allergies. Any cancer resulting from inhaling radon is not likely to arise for at least 20-30 years after exposure begins, and both the level of exposure and duration of exposure are factors which determine the risk of developing lung cancer.

Where are the highest levels of radon in the home?

Generally, the living area closest to the soil surface has the highest level of radon. Upper stories have lower levels of radon. Consequently, radon is rarely a concern in high rise apartment buildings, other than at ground level.

Do adjacent houses have similar levels of radon?

Because the amount of uranium and radium in the soil varies, and because houses are constructed and used in different ways, houses in the same neighborhood will have different radon levels.

Is there a safe level of radon?

We know that the greater the exposure to radon, the greater the risk of developing lung cancer. But we do not know if there is a radon level that is harmless. Both the duration of exposure and the level of radon in the air are important in determining the risk of developing lung cancer. Smoking may be a large contributing factor to lung disease associated with radon exposure. Currently, the California Department of Public Health (CDPH) **recommends that you take action to reduce radon levels in your house if the annual average indoor air concentration exceeds 4 picocuries per liter (pCi/L).**

How can radon levels be measured?

Several types of passive radon detectors or active devices can measure the level of radon in a house. Passive detectors are devices left in place for a period of time that require no ongoing activity or power. To obtain accurate results, the homeowner should carefully follow the manufacturer's instructions. Although short-term measurements of radon levels are more convenient, health risk can be more accurately determined from measurements made over a year. Active devices require a source of power and are used by professional radon testers to monitor radon levels. These devices are usually used during real estate transactions.

Where can I get a radon detector?

The CDPH Radon Program is now offering short term test kits for \$7.00 for California residents. CDPH has contracted with Alpha Energy Laboratories ([DrHomeAir](http://DrHomeAir.com)) to provide this service. The test kit can be ordered on-line at www.drhomeair.com/ . The CDPH Radon Program maintains lists of currently certified testers, mitigators and laboratories at www.cdph.ca.gov/HealthInfo/environhealth/Pages/RadonServiceProviders.aspx This list of certified radon providers can also be obtained by calling the CDPH Radon Program Hotline at (800) 745-7236.

What must be done to reduce indoor radon levels?

The U.S. EPA and CDPH recommend that homeowners attempt to reduce radon levels in any home that has an annual average level of radon at or above 4 pCi/L. The mitigation method chosen will depend on the construction of the house, extent of radon reduction required, and cost. After installing a mitigation system, we recommend that radon levels be monitored at regular intervals to make sure the mitigation is working.

A qualified contractor should install the radon mitigation system unless the homeowner fully understands the principles of the mitigation system.

When should water be tested for radon?

When a test shows that indoor levels of radon are at or above 4 picocuries per liter, homeowners should also consider a water test. If the water comes from a water system, information about the source of the water and any radon tests done on it can be obtained from the company supplying the water. For information or assistance with interpreting test results, contact the CDPH Division of Drinking Water and Environmental Management (see Appendix A) at .
www.cdph.ca.gov/programs/Pages/DDWEM.aspx .

The radon concentration of water from a private well can be measured by having a sample analyzed at a laboratory certified to test for radon in water. Homeowners should consult the CDPH radon program at (916) 449-5674 for guidance on the type of water analysis appropriate to the area and well type. The method of sample collection is critical. To get a list of certified laboratories, call the CDPH at (800) 745-7236 or visit their website at
www.cdph.ca.gov/HealthInfo/environhealth/Pages/RadonServiceProviders.aspx .

How can levels of radon in water be reduced?

Radon levels in water can be reduced by 99 percent by the installation of a granular activated carbon unit (GAC) on the water line entering the house. GAC units should be certified by the CDPH. As radon accumulates and decays in the GAC unit, the unit itself becomes radioactive. Therefore, these units must be shielded or located away from the house to protect occupants from radiation. The GAC filters also require special handling during replacement and disposal. Aeration may also remove radon from water. This technique may be more costly but avoids the problem of radiation build up. Selection of the proper water treatment technology depends primarily upon its removal efficiency (other contaminants in the water may adversely affect this), safety, initial costs, and operating and maintenance costs. Therefore, professional guidance is strongly advised.

Does the law require mitigation?

Mitigation of radon is not required by law and is at the discretion of the homeowner.

Hotlines:

For information on how to purchase a radon detector, how to find someone to test your home, or for informational publications on radon, call the CDPH Radon Program Hotline at: (800) 745-7236 or visit their website at

www.cdph.ca.gov/HealthInfo/environhealth/Pages/Radon.aspx

For specific assistance, call the CDPH Radon Program at: (916) 449-5674

Publications:

List of Certified Providers of Radon Services

This publication is available by calling CDPH Radon Program Hotline at (800) 745-745-7236 or at

www.cdph.ca.gov/HealthInfo/environhealth/Pages/RadonServiceProviders.aspx

California Department of Public Health

Indoor Radon Program

1616 Capitol Avenue, 2nd Floor

P.O. Box 997413

Sacramento, CA 95899-7413

Telephone: (800) 745-7236

Web: www.cdph.ca.gov/HealthInfo/environhealth/Pages/Radon.aspx

Radon in California

A Citizen's Guide to Radon

Homebuyers and Sellers Guide to Radon

The Inside Story - A Guide to Indoor Air Quality

How to Reduce Radon Levels in your Home

Model Standards for Radon in New Residential Buildings

These free publications are available from:

U.S. EPA Indoor Air Quality Information Clearinghouse

P.O. Box 37133

Washington, D.C. 20013-7133

Telephone: (800) 438-4318

Fax: (202) 484-1510

Email: iaqinfo@aol.com

Web: www.epa.gov/iaq/

Note: Telephone numbers and prices were correct at the date of publication of this booklet, but are subject to change.

Federal Agencies

**U.S. Department of Housing and Urban Development
(HUD)**

Office of Lead Hazard Control
451 7th Street S.W., Room B133
Washington, D.C. 20410
Telephone: (202) 755-1785
Web: www.hud.gov
HUD helps people build and maintain communities of opportunity.

U.S. Environmental Protection Agency (U.S. EPA)

Public Information Center
1200 Pennsylvania Ave., N.W.
Washington, D.C. 20460
Telephone: (202) 272-0167
Web: www.epa.gov
The U.S. EPA is a regulatory agency responsible for implementing federal laws designed to protect our air, water, and land from past and future environmental hazards.

State Agencies

California Air Resources Board

Research Division
Indoor Exposure Assessment Section
1001 I Street
P.O. Box 2815
Sacramento, CA 95814
Telephone: (916) 322-8282
Web: www.arb.ca.gov

California Contractor's State License Board

9821 Business Park Drive
P.O. Box 26000
Sacramento, CA 95827
Telephone: (800) 321-2752
Web: www.contractorslicense.com
This board is responsible for licensing contractors, including asbestos abatement.

California Department of Industrial Relations

Division of Occupational Safety and Health (Cal/OSHA)
Asbestos Consultant Certification Unit
2211 Park Towne Circle, #1
Sacramento, CA 95825
Telephone: (916) 574-2993
Web: www.dir.ca.gov
Cal/OSHA is the state equivalent to the Federal Occupational

Safety and Health Administration (OSHA) and regulates protection of workers.

California Department of Public Health

Call your local county health department listed in the front of the white pages or, on the Internet, visit www.cdph.ca.gov

California Department of Public Health

Environmental Management Branch, Radon Program
1616 Capital Avenue, 2nd Floor, MS 7405
P.O. Box 997413
Sacramento, CA 95899-7413
Telephone: (800) 745-7236

Web: www.cdph.ca.gov/HealthInfo/environhealth/Pages/Radon.aspx
This branch provides publications and information about radon hazards.

California Department of Public Health

Environmental Lab Accreditation Program
850 Marina Bay Parkway
Building P, Third Floor
Richmond, CA 94804-6403
Telephone: (510) 620-5600

APPENDIX A List of Federal and State Agencies

Contact information provided was correct as of the date of publication, but is subject to change.

This office may provide information about test procedures for analyzing environmental pollutants.

California Department of Public Health

Division of Drinking Water and Environmental Management

Drinking Water Technical Program Branch

Sacramento Headquarters

1616 Capital Avenue, MS 7400

P.O. Box 997413

Sacramento, CA 95899-7413

Telephone: (916) 449-5600

This division collects and evaluates water quality information on drinking water in California and supervises the activities of all public water systems. It also provides assistance to local health departments, water purveyors, and the general public on issues related to water quality, water supply, and water treatment:

Northern California Section

Sacramento District

8455 Jackson Road, Room 120

Sacramento, CA 95826

Telephone: (916) 229-3126

Lassen, Valley, Klamath & Shasta Districts

415 Knollcrest Drive, Suite 110

Redding, CA 96002

Telephone: (916) 224-4800

North Coastal Section

San Francisco & Santa Clara Districts

2151 Berkeley Way, Room 458

Berkeley, CA 94704

Telephone: (510) 540-2158

Mendocino & Sonoma Districts

50 D Street, Suite 200

Santa Rosa, CA 95404-4752

Telephone: (707) 576-2145
Monterey District
1 Lower Ragsdale, Bldg. 1, Suite 120
Monterey, CA 93940
Telephone: (831) 655-6939

Central California Section
Merced & Visalia Districts
1040 East Herndon Avenue, Suite 205
Fresno, CA 93720-3158
Telephone: (559) 447-3300

Stockton District
31 E. Channel Street, Room 270
Stockton, CA 95202
Telephone: (209) 948-7696

Tehachapi District
1200 Discovery Drive, Suite 100
Bakersfield, CA 993309
Telephone: (661) 335-7315

Southern California Section
Los Angeles District & Metropolitan Districts
1449 W. Temple Street, Room 202
Los Angeles, CA 90026
Telephone: (213) 580-5723

Santa Barbara District
1180 Eugenia Place, Suite 200
Carpinteria, CA 93013
Telephone: (805) 566-1326

South Coastal Section
San Bernardino District
464 West 4th Street, #437
San Bernardino, CA 92401
Telephone: (909) 383-4328

San Diego & Riverside Districts
1350 Front Street, Room 2050
San Diego, CA 92101
Telephone: (619) 525-4159

Santa Ana District
28 Civic Center Plaza, Room 325

Santa Ana, CA 92701
Telephone: (714) 558-4410California

**Department of Toxic Substances
Control**

1001 I Street
P.O. Box 806
Sacramento, CA 95812-0806
Telephone: (916) 324-1826
Web: www.dtsc.ca.gov

DTSC issues permits for treatment, storage, and disposal of hazardous wastes; inspects facilities; maintains a Superfund list; and has a site cleanup program.

Northern California Regional Offices

Sacramento Office
8800 Cal Center Drive
Sacramento, CA 95826-3268
Telephone: (916) 255-3618

Clovis Office
1515 Tollhouse Road
Clovis, CA 93611-0522
Telephone: (559) 297-3901

Berkeley Office
700 Heinz Avenue, Suite #200
Berkeley, CA 94710-2721
Telephone: (510) 540-2122

Southern California Regional Offices

Chatsworth Office
9211 Oakdale Avenue
Chatsworth, CA 91311-6505
Phone: (818) 717-6500

Cypress Office
5796 Corporate Avenue
Cypress, CA 90630-4732
Telephone: (714) 484-5300

San Diego Office
9174 Skypark Court, Suite 150
San Diego, CA 92123
Telephone: (858) 637-5531

**California Department of Housing and Community
Development**

Division of Administration - Manufactured Housing
1800 Third Street, Room 260

P.O. Box 31
Sacramento, CA 95814
Telephone: (916) 445-3338
Administration of codes and statutes relating to mobile homes. It also allocates grants and loans for low-income housing, house rehabilitation, and disaster relief.

California Department of Real Estate (DRE)

Fresno District Office
Department of Real Estate
2550 Mariposa, Room 3070
Fresno, CA 93721-2273
Telephone: (559) 445-6153

Oakland District Office
Department of Real Estate
1515 Clay Street, Room 702
Oakland, CA 94612-1462
Telephone: (510) 622-2552

Los Angeles Executive Office
Department of Real Estate
320 W. 4th Street, Suite 350
Los Angeles, CA 90013-1150
Telephone: (213) 620-2072

San Diego District Office
Department of Real Estate
1350 Front Street, Room 3064
San Diego, CA 92101-3687
Telephone: (619) 525-4375

Sacramento Principal Office
Department of Real Estate
2201 Broadway
P.O. Box 187000
Sacramento, CA 95818-7000
Telephone: (916) 227-0864
This unit provides information on lead toxicity and treatment of lead toxicity in children.

APPENDIX B Glossary

AERATION: A technique by which air is introduced into a liquid; bubbles and aerosols are generated and dissolved gases released. For example, water aerated by passing through a shower head will release dissolved radon gas.

ACTIVATED CARBON: A material made from burnt wood which is used to remove organic solutes, such as pesticides, and some inorganic solutes, such as chlorine, from water. Dissolved organic solutes are removed from the water by absorption onto the activated carbon. The activated carbon must be periodically replaced when it becomes saturated and unable to adsorb any more solute. Activated carbon is not effective in removing heavy metals, such as lead, and salts, which make water hard.

ANNUAL AVERAGE LEVEL: The average of measurements taken at different times over the period of one year or the level measured by a device left in place for a full year.

CARCINOGEN: A substance that causes cancer.

CATHODE RAY TUBE: The cathode ray tube, or CRT, is the display device used in most computer displays, video monitors, and televisions.

CERTIFIED LABORATORY: A laboratory that has demonstrated that it can meet the federal and state standards for accuracy and precision for a given analytical procedure.

DISTILLATION: As referenced in this booklet, distillation is a technique used to purify water by removal of inorganic contaminants such as salts through heating the solution and condensing the steam. The resultant distilled water has a reduced salt concentration. Distillation is not effective in removing pesticides and volatile organic contaminants such as chloroform and benzene.

EXPOSURE: Contact with an agent through inhalation, ingestion, or touching. For example, exposure to radon is primarily through inhalation; exposure to lead is primarily through ingestion.

FILTRATION: Purification of water by removing undissolved solids or sediment by passing the water through a filter or sieve. Filtration does not remove dissolved salts or organic contaminants.

FRIABLE: Easily crumbled, pulverized, or reduced to a powder by hand.

LEVEL: Another term for concentration; also, the amount of a substance in a given volume of air, liquid or solid.

LITER: Metric unit of volume equivalent to 1.057 quarts of liquid. One gallon is equivalent to about four liters.

MILLIGRAM: A unit of weight. There are 1,000 milligrams in one gram and about 28 grams in one ounce.

MITIGATION: Mitigation means any action taken to reduce or eliminate the risk to human health and the environment from hazardous waste.

PARTS PER MILLION: A unit of concentration. For example, air that contains 1 part per million formaldehyde contains 1.2 milligrams formaldehyde in 1 million milliliters air, i.e. 1,000 liters air. Also, water which contains 1 part per million lead contains 1 milligram lead in 1 million milligrams water, i.e., 1 kilogram water. One part per million can be compared to one cent in ten thousand dollars.

PASSIVE DETECTOR: A measuring device that functions without any energy input or ongoing attention from the user. For example, use of a passive radon detector to measure radon requires only that the detector be left in place for a specified time.

PICOCURIE: A unit of amount used in measurement of radioactive substances. For example, five picocuries of radon are five trillionths of a curie and are equivalent to 11 radioactive radon atoms decaying every minute.

RADIOACTIVE: A term used to describe atoms that are unstable and break down or decay to form another kind of atom. For example, radium breaks down to form radon. In the process of decay some high-energy particles are emitted. The detection of these particles by special instruments indicates that a substance is radioactive. The high-energy particles and gamma rays are called radiation.

REACTIVE: A solid waste that is normally unstable, reacts violently with water, or generates toxic gases when exposed to water or other materials.

REVERSE OSMOSIS: A technology used to purify water by removing the salts from water. Osmosis involves the diffusion of water from a dilute to a concentrated solution across a semi-permeable membrane that allows only the passage of water. In reverse osmosis, water is forced through a semi-permeable membrane from a concentrated solution to a stream of purified water. For example, in the desalination of seawater, reverse osmosis is used to separate the salts from the water generating drinking water and a residue of salts.

RISK: In the context of this booklet, risk indicates the chance of developing a disease after exposure to an environmental hazard. Risk depends on the time period for which a person is exposed to a particular hazard and the level of the hazard.

SOFT WATER: Water that does not contain large amounts of dissolved minerals such as salts containing calcium or magnesium.

SOLDER: A metallic compound used to seal joints between pipes. Until recently, most solder contained about 50 percent lead. Lead solder is now banned for plumbing applications.

TOXICITY: The extent to which a material is toxic.

Are You Planning To Buy, Rent, or Renovate a Home Built Before 1978?

Many houses and apartments built before 1978 have paint that contains high levels of lead (called lead-based paint). Lead from paint, chips, and dust can pose serious health hazards if not taken care of properly.

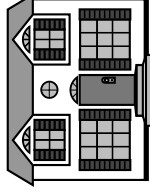

OWNERS, BUYERS, and RENTERS are encouraged to check for lead (see page 6) before renting, buying or renovating pre-1978 housing.

Federal law requires that individuals receive certain information before renting, buying, or renovating pre-1978 housing:

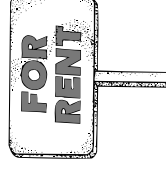

LANDLORDS have to disclose known information on lead-based paint and lead-based paint hazards before leases take effect. Leases must include a disclosure about lead-based paint.

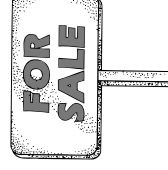

SELLERS have to disclose known information on lead-based paint and lead-based paint hazards before selling a house. Sales contracts must include a disclosure about lead-based paint. Buyers have up to 10 days to check for lead.



RENOVATORS disturbing more than 2 square feet of painted surfaces have to give you this pamphlet before starting work.

Protect Your Family From Lead In Your Home

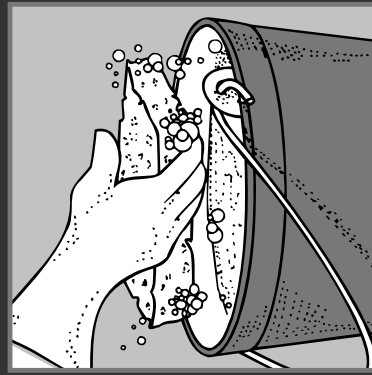
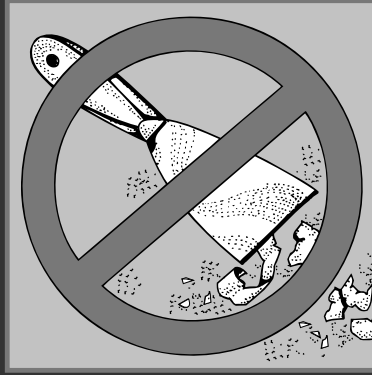
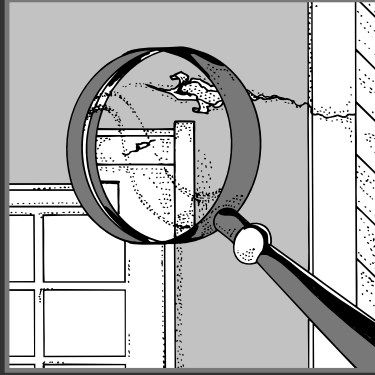

EPA United States Environmental Protection Agency



United States Consumer Product Safety Commission



United States Department of Housing and Urban Development

IMPORTANT!

Lead From Paint, Dust, and Soil Can Be Dangerous If Not Managed Properly

- FACT:** Lead exposure can harm young children and babies even before they are born.
- FACT:** Even children who seem healthy can have high levels of lead in their bodies.
- FACT:** People can get lead in their bodies by breathing or swallowing lead dust, or by eating soil or paint chips containing lead.
- FACT:** People have many options for reducing lead hazards. In most cases, lead-based paint that is in good condition is not a hazard.
- FACT:** Removing lead-based paint improperly can increase the danger to your family.

If you think your home might have lead hazards, read this pamphlet to learn some simple steps to protect your family.

Lead Gets in the Body in Many Ways

Childhood lead poisoning remains a major environmental health problem in the U.S.

- People can get lead in their body if they:**
- ◆ Breathe in lead dust (especially during renovations that disturb painted surfaces).
 - ◆ Put their hands or other objects covered with lead dust in their mouths.
 - ◆ Eat paint chips or soil that contains lead.

Lead is even more dangerous to children under the age of 6:

- ◆ At this age children's brains and nervous systems are more sensitive to the damaging effects of lead.
- ◆ Children's growing bodies absorb more lead.
- ◆ Babies and young children often put their hands and other objects in their mouths. These objects can have lead dust on them.

Even children who appear healthy can have dangerous levels of lead in their bodies.

Lead is also dangerous to women of childbearing age:

- ◆ Women with a high lead level in their system prior to pregnancy would expose a fetus to lead through the placenta during fetal development.

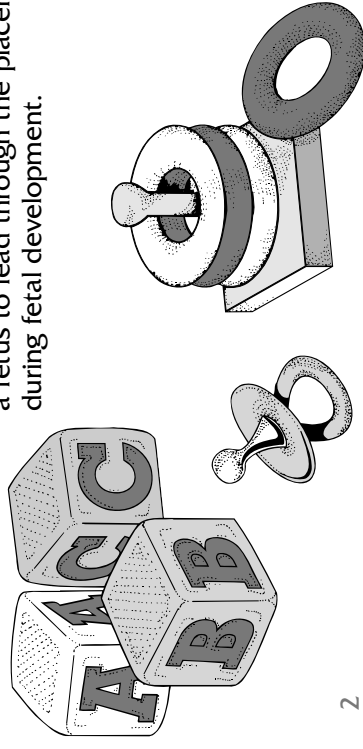

Lead's Effects

It is important to know that even exposure to low levels of lead can severely harm children.

In children, lead can cause:

- ◆ Nervous system and kidney damage.
- ◆ Learning disabilities, attention deficit disorder, and decreased intelligence.
- ◆ Speech, language, and behavior problems.
- ◆ Poor muscle coordination.
- ◆ Decreased muscle and bone growth.
- ◆ Hearing damage.

While low-lead exposure is most common, exposure to high levels of lead can have devastating effects on children, including seizures, unconsciousness, and, in some cases, death.

Although children are especially susceptible to lead exposure, lead can be dangerous for adults too.

In adults, lead can cause:

- ◆ Increased chance of illness during pregnancy.
- ◆ Harm to a fetus, including brain damage or death.
- ◆ Fertility problems (in men and women).
- ◆ High blood pressure.
- ◆ Digestive problems.
- ◆ Nerve disorders.
- ◆ Memory and concentration problems.
- ◆ Muscle and joint pain.

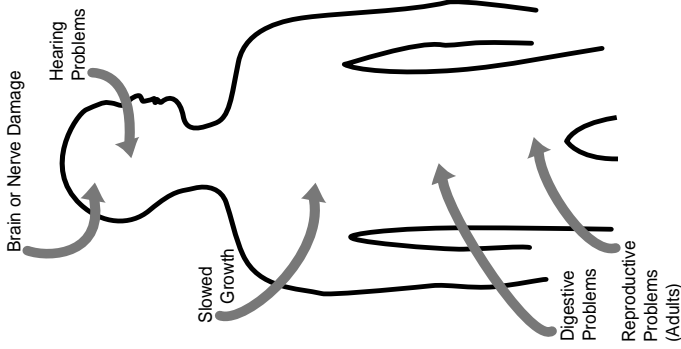

Lead affects the body in many ways.

Where Lead-Based Paint Is Found

In general, the older your home, the more likely it has lead-based paint.

Many homes built before 1978 have lead-based paint. The federal government banned lead-based paint from housing in 1978. Some states stopped its use even earlier. Lead can be found:

- ◆ In homes in the city, country, or suburbs.
- ◆ In apartments, single-family homes, and both private and public housing.
- ◆ Inside and outside of the house.
- ◆ In soil around a home. (Soil can pick up lead from exterior paint or other sources such as past use of leaded gas in cars.)

Checking Your Family for Lead

Get your children and home tested (especially if your home has paint in poor condition and was built before 1978), and fix any hazards you may have.

Children's blood lead levels tend to increase rapidly from 6 to 12 months of age, and tend to peak at 18 to 24 months of age.

Consult your doctor for advice on testing your children. A simple blood test can detect high levels of lead. Blood tests are usually recommended for:

- ◆ Children at ages 1 and 2.
 - ◆ Children or other family members who have been exposed to high levels of lead.
 - ◆ Children who should be tested under your state or local health screening plan.
- Your doctor can explain what the test results mean and if more testing will be needed.

Identifying Lead Hazards

Lead-based paint is usually not a hazard if it is in good condition, and it is not on an impact or friction surface, like a window. It is defined by the federal government as paint with lead levels greater than or equal to 1.0 milligram per square centimeter, or more than 0.5% by weight.

Deteriorating lead-based paint (peeling, chipping, chalking, cracking or damaged) is a hazard and needs immediate attention. It may also be a hazard when found on surfaces that children can chew or that get a lot of wear-and-tear, such as:

- ◆ Windows and window sills.
- ◆ Doors and door frames.
- ◆ Stairs, railings, banisters, and porches.

Lead dust can form when lead-based paint is scraped, sanded, or heated. Dust also forms when painted surfaces bump or rub together. Lead chips and dust can get on surfaces and objects that people touch. Settled lead dust can re-enter the air when people vacuum, sweep, or walk through it. The following two federal standards have been set for lead hazards in dust:

- ◆ 40 micrograms per square foot ($\mu\text{g}/\text{ft}^2$) and higher for floors, including carpeted floors.
- ◆ 250 $\mu\text{g}/\text{ft}^2$ and higher for interior window sills.

Lead in soil can be a hazard when children play in bare soil or when people bring soil into the house on their shoes. The following two federal standards have been set for lead hazards in residential soil:

- ◆ 400 parts per million (ppm) and higher in play areas of bare soil.
- ◆ 1,200 ppm (average) and higher in bare soil in the remainder of the yard.

The only way to find out if paint, dust and soil lead hazards exist is to test for them. The next page describes the most common methods used.

Checking Your Home for Lead

Just knowing that a home has lead-based paint may not tell you if there is a hazard.

You can get your home tested for lead in several different ways:

- ◆ A paint **inspection** tells you whether your home has lead-based paint and where it is located. It won't tell you whether or not your home currently has lead hazards.
- ◆ A **risk assessment** tells you if your home currently has any lead hazards from lead in paint, dust, or soil. It also tells you what actions to take to address any hazards.
- ◆ A combination risk assessment and inspection tells you if your home has any lead hazards and if your home has any lead-based paint, and where the lead-based paint is located.

Hire a trained and certified testing professional who will use a range of reliable methods when testing your home.

- ◆ Visual inspection of paint condition and location.
- ◆ A portable x-ray fluorescence (XRF) machine.
- ◆ Lab tests of paint, dust, and soil samples.

There are state and federal programs in place to ensure that testing is done safely, reliably, and effectively. Contact your state or local agency (see bottom of page 11) for more information, or call **1-800-424-LEAD (5323)** for a list of contacts in your area.

Home test kits for lead are available, but may not always be accurate. Consumers should not rely on these kits before doing renovations or to assure safety.



What You Can Do Now To Protect Your Family

If you suspect that your house has lead hazards, you can take some immediate steps to reduce your family's risk:

- ◆ If you rent, notify your landlord of peeling or chipping paint.
- ◆ Clean up paint chips immediately.
- ◆ Clean floors, window frames, window sills, and other surfaces weekly. Use a mop or sponge with warm water and a general all-purpose cleaner or a cleaner made specifically for lead. REMEMBER: NEVER MIX AMMONIA AND BLEACH PRODUCTS TOGETHER SINCE THEY CAN FORM A DANGEROUS GAS.
- ◆ Thoroughly rinse sponges and mop heads after cleaning dirty or dusty areas.
- ◆ Wash children's hands often, especially before they eat and before nap time and bed time.
- ◆ Keep play areas clean. Wash bottles, pacifiers, toys, and stuffed animals regularly.
- ◆ Keep children from chewing window sills or other painted surfaces.
- ◆ Clean or remove shoes before entering your home to avoid tracking in lead from soil.
- ◆ Make sure children eat nutritious, low-fat meals high in iron and calcium, such as spinach and dairy products. Children with good diets absorb less lead.

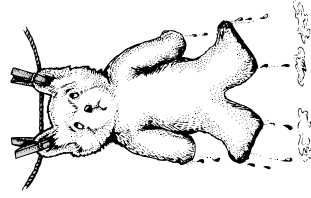
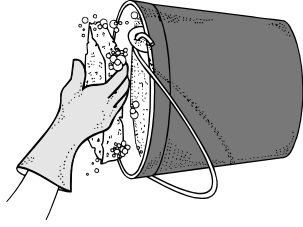

7

Reducing Lead Hazards In The Home

In addition to day-to-day cleaning and good nutrition:

- ◆ You can **temporarily** reduce lead hazards by taking actions such as repairing damaged painted surfaces and planting grass to cover soil with high lead levels. These actions (called “interim controls”) are not permanent solutions and will need ongoing attention.
- ◆ To **permanently** remove lead hazards, you should hire a certified lead “abatement” contractor. Abatement (or permanent hazard elimination) methods include removing, sealing, or enclosing lead-based paint with special materials. Just painting over the hazard with regular paint is not permanent removal.

Always hire a person with special training for correcting lead problems—someone who knows how to do this work safely and has the proper equipment to clean up thoroughly. Certified contractors will employ qualified workers and follow strict safety rules as set by their state or by the federal government.

Once the work is completed, dust cleanup activities must be repeated until testing indicates that lead dust levels are below the following:

- ◆ 40 micrograms per square foot ($\mu\text{g}/\text{ft}^2$) for floors, including carpeted floors;
- ◆ 250 $\mu\text{g}/\text{ft}^2$ for interior window sills; and
- ◆ 400 $\mu\text{g}/\text{ft}^2$ for window troughs.

Call your state or local agency (see bottom of page 11) for help in locating certified professionals in your area and to see if financial assistance is available.

Removing lead improperly can increase the hazard to your family by spreading even more lead dust around the house.

Always use a professional who is trained to remove lead hazards safely.

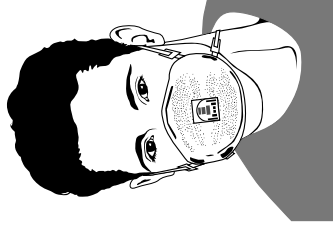

8

Remodeling or Renovating a Home With Lead-Based Paint

Take precautions before your contractor or you begin remodeling or renovating anything that disturbs painted surfaces (such as scraping off paint or tearing out walls):

- ◆ **Have the area tested for lead-based paint.**
- ◆ **Do not use a belt-sander, propane torch, high temperature heat gun, dry scraper, or dry sandpaper** to remove lead-based paint. These actions create large amounts of lead dust and fumes. Lead dust can remain in your home long after the work is done.
- ◆ **Temporarily move your family** (especially children and pregnant women) out of the apartment or house until the work is done and the area is properly cleaned. If you can't move your family, at least completely seal off the work area.

- ◆ **Follow other safety measures to reduce lead hazards.** You can find out about other safety measures by calling 1-800-424-LEAD. Ask for the brochure "Reducing Lead Hazards When Remodeling Your Home." This brochure explains what to do before, during, and after renovations.

If you have already completed renovations or remodeling that could have released lead-based paint or dust, get your young children tested and follow the steps outlined on page 7 of this brochure.

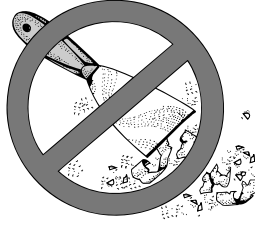

If not conducted properly, certain types of renovations can release lead from paint and dust into the air.



Other Sources of Lead

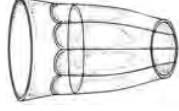

- ◆ **Drinking water.** Your home might have plumbing with lead or lead solder. Call your local health department or water supplier to find out about testing your water. You cannot see, smell, or taste lead, and boiling your water will not get rid of lead. If you think your plumbing might have lead in it:

- Use only cold water for drinking and cooking.
- Run water for 15 to 30 seconds before drinking it, especially if you have not used your water for a few hours.

While paint, dust, and soil are the most common sources of lead, other lead sources also exist.

- ◆ **The job.** If you work with lead, you could bring it home on your hands or clothes. Shower and change clothes before coming home. Launder your work clothes separately from the rest of your family's clothes.

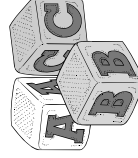

- ◆ **Old painted toys and furniture.**
- ◆ **Food and liquids stored in lead crystal or lead-glazed pottery or porcelain.**
- ◆ **Lead smelters** or other industries that release lead into the air.
- ◆ **Hobbies** that use lead, such as making pottery or stained glass, or refinishing furniture.
- ◆ **Folk remedies** that contain lead, such as "greta" and "azarcon" used to treat an upset stomach.

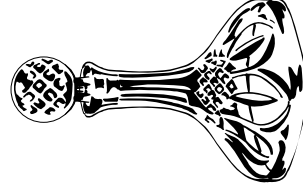

For More Information

The National Lead Information Center

Call **1-800-424-LEAD (424-5323)** to learn how to protect children from lead poisoning and for other information on lead hazards. To access lead information via the web, visit www.epa.gov/lead and www.hud.gov/offices/lead/.

EPA's Safe Drinking Water Hotline

Call **1-800-426-4791** for information about lead in drinking water.

Consumer Product Safety Commission (CPSC) Hotline

To request information on lead in consumer products, or to report an unsafe consumer product or a product-related injury call **1-800-638-2772**, or visit CPSC's Web site at: www.cpsc.gov.

Health and Environmental Agencies

Some cities, states, and tribes have their own rules for lead-based paint activities. Check with your local agency to see which laws apply to you. Most agencies can also provide information on finding a lead abatement firm in your area, and on possible sources of financial aid for reducing lead hazards. Receive up-to-date address and phone information for your local contacts on the Internet at www.epa.gov/lead or contact the National Lead Information Center at **1-800-424-LEAD**.

For the hearing impaired, call the Federal Information Relay Service at **1-800-877-8339** to access any of the phone numbers in this brochure.

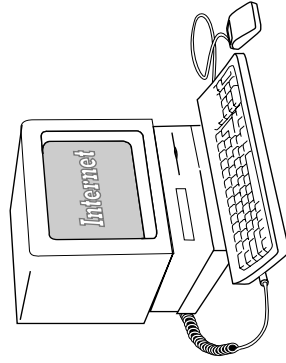
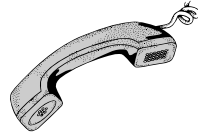

EPA Regional Offices

Your Regional EPA Office can provide further information regarding regulations and lead protection programs.

EPA Regional Offices

Region 1 (Connecticut, Massachusetts, Maine, New Hampshire, Rhode Island, Vermont)

Regional Lead Contact
U.S. EPA Region 1
Suite 1100 (CPT)
One Congress Street
Boston, MA 02114-2023
1 (888) 372-7341

Region 6 (Arkansas, Louisiana, New Mexico, Oklahoma, Texas)

Regional Lead Contact
U.S. EPA Region 6
1445 Ross Avenue, 12th Floor
Dallas, TX 75202-2733
(214) 665-7577

Region 2 (New Jersey, New York, Puerto Rico, Virgin Islands)

Regional Lead Contact
U.S. EPA Region 2
2890 Woodbridge Avenue
Building 209, Mail Stop 225
Edison, NJ 08837-3679
(732) 321-6671

Region 7 (Iowa, Kansas, Missouri, Nebraska)

Regional Lead Contact
U.S. EPA Region 7
(ARTD-RAL)
901 N. 5th Street
Kansas City, KS 66101
(913) 551-7020

Region 3 (Delaware, Maryland, Pennsylvania, Virginia, Washington DC, West Virginia)

Regional Lead Contact
U.S. EPA Region 3 (3WC33)
1650 Arch Street
Philadelphia, PA 19103
(215) 814-5000

Region 8 (Colorado, Montana, North Dakota, South Dakota, Utah, Wyoming)

Regional Lead Contact
U.S. EPA Region 8
999 18th Street, Suite 500
Denver, CO 80202-2466
(303) 312-6021

Region 4 (Alabama, Florida, Georgia, Kentucky, Mississippi, North Carolina, South Carolina, Tennessee)

Regional Lead Contact
U.S. EPA Region 4
61 Forsyth Street, SW
Atlanta, GA 30303
(404) 562-8998

Region 9 (Arizona, California, Hawaii, Nevada)

Regional Lead Contact
U.S. Region 9
75 Hawthorne Street
San Francisco, CA 94105
(415) 947-4164

Region 5 (Illinois, Indiana, Michigan, Minnesota, Ohio, Wisconsin)

Regional Lead Contact
U.S. EPA Region 5 (DT-8)
77 West Jackson Boulevard
Chicago, IL 60604-3666
(312) 886-6003

Region 10 (Alaska, Idaho, Oregon, Washington)

Regional Lead Contact
U.S. EPA Region 10
Toxics Section WCM-128
1200 Sixth Avenue
Seattle, WA 98101-1128
(206) 553-1985

CPSC Regional Offices

Your Regional CPSC Office can provide further information regarding regulations and consumer product safety.

Eastern Regional Center
Consumer Product Safety Commission
201 Varick Street, Room 903
New York, NY 10014
(212) 620-4120

Western Regional Center
Consumer Product Safety Commission
1301 Clay Street, Suite 610-N
Oakland, CA 94612
(510) 637-4050

Central Regional Center
Consumer Product Safety Commission
230 South Dearborn Street, Room 2944
Chicago, IL 60604
(312) 353-8260

HUD Lead Office

Please contact HUD's Office of Healthy Homes and Lead Hazard Control for information on lead regulations, outreach efforts, and lead hazard control and research grant programs.

U.S. Department of Housing and Urban Development
Office of Healthy Homes and Lead Hazard Control
451 Seventh Street, SW, P-3206
Washington, DC 20410
(202) 755-1785

This document is in the public domain. It may be reproduced by an individual or organization without permission. Information provided in this booklet is based upon current scientific and technical understanding of the issues presented and is reflective of the jurisdictional boundaries established by the statutes governing the co-authoring agencies. Following the advice given will not necessarily provide complete protection in all situations or against all health hazards that can be caused by lead exposure.

U.S. EPA Washington DC 20460
U.S. CPSC Washington DC 20207
U.S. HUD Washington DC 20410

EPA747-K-99-001
June 2003

Simple Steps To Protect Your Family From Lead Hazards

If you think your home has high levels of lead:

- ◆ Get your young children tested for lead, even if they seem healthy.
- ◆ Wash children's hands, bottles, pacifiers, and toys often.
- ◆ Make sure children eat healthy, low-fat foods.
- ◆ Get your home checked for lead hazards.
- ◆ Regularly clean floors, window sills, and other surfaces.
- ◆ Wipe soil off shoes before entering house.
- ◆ Talk to your landlord about fixing surfaces with peeling or chipping paint.
- ◆ Take precautions to avoid exposure to lead dust when remodeling or renovating (call 1-800-424-LEAD for guidelines).
- ◆ Don't use a belt-sander, propane torch, high temperature heat gun, scraper, or sandpaper on painted surfaces that may contain lead.
- ◆ Don't try to remove lead-based paint yourself.



What is your



Home
**ENERGY
RATING**

know before you buy or sell

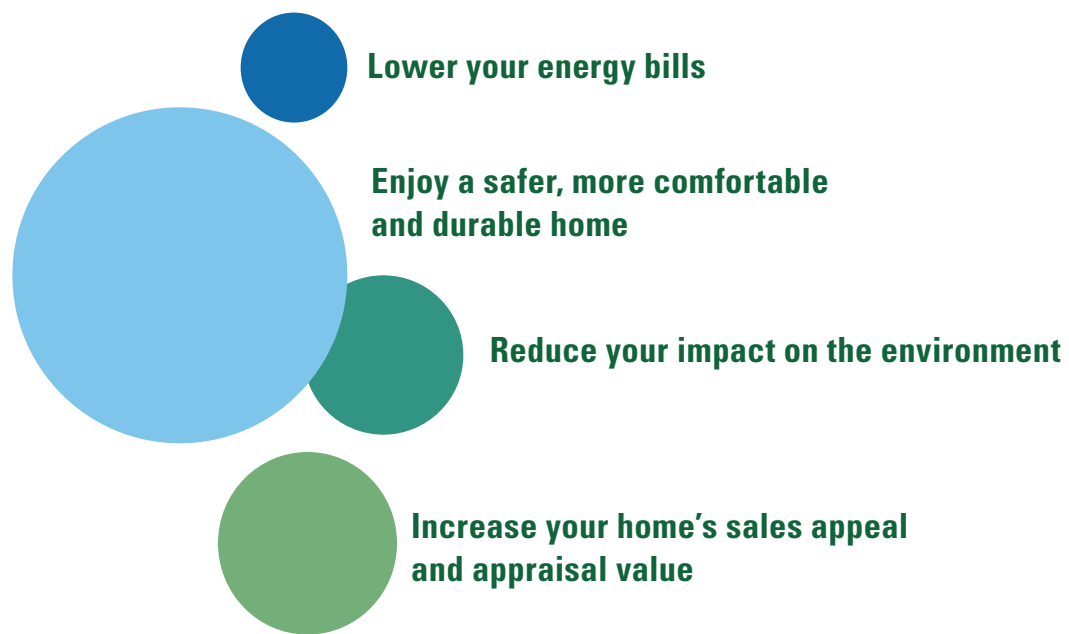

What
is your

Home
**ENERGY
RATING**

Whether you are buying or selling a residential property, or staying in your current home, every Californian should know his or her home **energy rating.**

Contents

Know the Facts	4
What Is a Home Energy Rating?	5
Understanding Your HERS Index	6
HERS Recommendations	7
Making Wise Improvements	8
Utility Bills and Ratings	9
Financing Your Improvements	10
Efficiency Adds Value	12
Go Solar California!	13

What is your Home ENERGY RATING?

California is a national leader in promoting energy efficiency. As a result, our energy use per person has remained stable for over 30 years while the national average has steadily increased. Despite this success, we must continue to reduce energy use in our homes. The benefits are highly valuable – reducing energy use not only lowers your energy bills, but helps our electricity system remain reliable, even during high peak-load periods, while also protecting our environment.

In 2006, California established aggressive goals to reduce greenhouse gases that cause global warming. These goals will cut today's carbon emissions by 25 percent, so we can return to 1990 levels by the year 2020. Efforts to accomplish this goal represent important first steps in addressing the threat of global warming. We owe our children and grandchildren nothing less.

As you consider the sale or purchase of your home, this booklet asks that you recognize what energy efficiency measures have been built into the home, or ways to make further improvements to save energy and reduce peak electricity demand.

Your energy efficiency actions help make California a better, more environmentally sustainable place to raise your families.

Whether you are buying or selling a residential property, or staying in your current home, every Californian should know his or her home energy rating. Wasted energy wastes more than just your money – it changes our climate. The scientific community agrees that we must act now or risk facing an uncertain future.

The California Home Energy Rating System (HERS) Program provides a reliable way to estimate and compare the energy efficiency of California homes and identify wise energy saving

improvements. This booklet explains how the HERS program works and helps you find a qualified professional to rate your own home. Once you know your home energy rating, you will be able to choose smart energy upgrades and investments that will benefit your family now... and generations to come.

During a real estate transaction, a California HERS Rating is a great way to disclose facts about the energy efficiency of a home.

Know the
FACTS

Whether you are getting ready to sell your home – or preparing to buy one – knowing the energy efficiency facts about the property is a major consideration. As buyers become more aware of the benefits of an energy-efficient home, homes with a favorable home energy rating may be more attractive to buyers.

Have you checked your ducts?

Heating and cooling ducts in an average California home leak almost 30 percent. That is why when heating or cooling equipment is replaced, testing the system's ducts for leaks is now required by building officials in many parts of the state.

If you are selling your home and had upgrades made without the required permits or duct testing, be sure to disclose this on your Real Estate Transfer Disclosure Statement. If you are preparing to buy a home that had duct work performed after October 2005, ask to see the duct testing report, or an explanation as to why such testing was not required.

For more information, visit:
www.energy.ca.gov/title24/changeout/

Selling?

A HERS rating will:

- Help determine facts about the energy efficiency of your home.
- Identify energy improvements that may make your home more attractive to buyers.
- Alert appraisers to add value for any energy improvements you may have made already.

Buying?

- Use a HERS rating to shop and compare the energy efficiency of homes you are considering.
- Learn about the most cost-effective options for lowering the energy bills in any home you are considering buying.
- Identify and qualify for energy efficiency financing.

Staying in your current home?

- Find out your HERS rating.
- Discover the best options for lowering your energy bills.
- Identify energy efficiency improvements that may also make your home more comfortable.
- Find resources to help finance your improvements.
- Improve your home's resale value.



You wouldn't buy a new car without knowing its "miles per gallon" rating. So why buy a home without a "home energy rating?"

What is a
**HOME
ENERGY
RATING**

A Whole-House Home Energy Rating is a comprehensive evaluation of the efficiency of the entire home. The homeowner receives a written report that includes a numeric score or "rating" of the home, plus recommendations for improvements that will reduce energy bills and make the home more comfortable. Knowing the energy rating of your home is similar to knowing the miles per gallon rating of your car.

The California Energy Commission has developed the California Home Energy Rating System (HERS) Program to cover almost every type of residence in California. This includes new and existing single-family homes and multifamily buildings of three stories or less. Energy Commission-approved HERS Providers train, certify, and oversee a new type of service professional known as a "California Whole-House Home Energy Rater."

Each California HERS Rater must follow standardized energy auditing procedures and use energy analysis software that meets the Energy Commission's technical requirements. The HERS Rater will inspect and assess all the major energy efficiency features of your home:

- Air leaks (sealed or unsealed)
- Cooling system
- Heating system
- Water heating system
- Heating and cooling ducts and/or pipes
- Insulation (attic, walls, floor)
- Windows
- Attached lighting fixtures
- Major appliances
- Solar electricity generating systems (if any)
- Other energy uses

Your HERS report will identify the most cost-effective and appropriate energy efficiency improvements for your home. Only a properly prepared HERS Report will receive an official California Home Energy Rating Certificate with the California Energy Commission's seal.

Rating costs vary depending on factors such as the size and features of your home and the extent of rater services needed. Ask your real estate agent for names of certified HERS Raters in your area or find an Energy Commission-approved HERS Provider at: www.energy.ca.gov/HERS/index.html or call the Energy Hotline at (800) 772-3300.

Your HERS Rating Certificate will:

- Display an official HERS Index efficiency rating on a 0 to 250-point scale.
- Itemize the home's major energy-efficiency features as determined by the HERS Rater.
- Estimate the home's annual energy use, operating cost, and greenhouse gas emissions.
- Calculate the amount of solar or other onsite renewable energy that the home may produce.

Understanding your HERS index

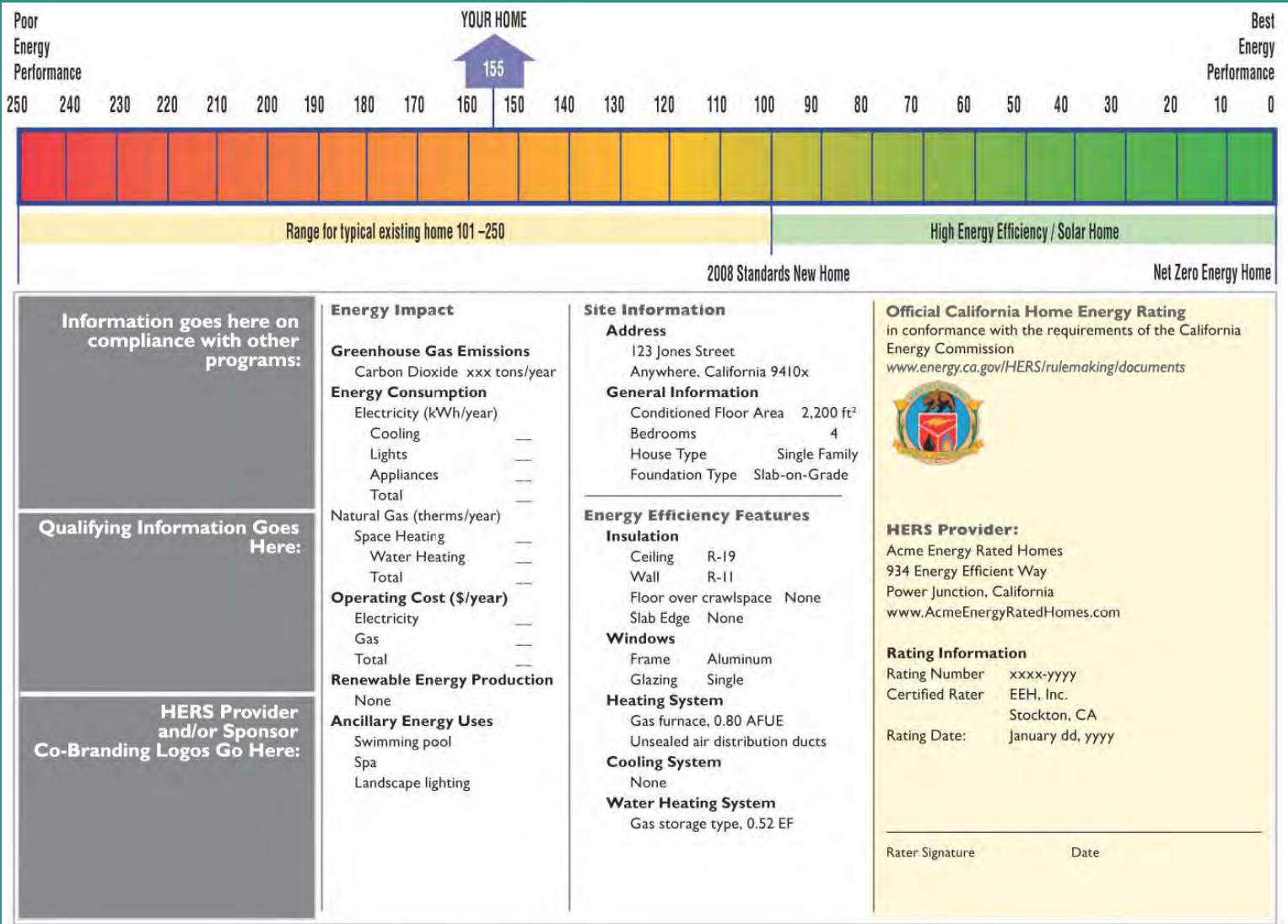

*What is your Home Energy Rating?
How low can it go?*

**A lower HERS Index indicates a more energy efficient home.
A home with a HERS Index of:**

- "250" or more is likely to have very high energy bills, and many opportunities for efficiency improvements.
- "100" uses the same energy as a new home that meets California's 2008 Building Energy Efficiency Standards.
- "0" is a super-efficient "Net Zero Energy Home" that consumes no more energy than it produces with solar or other onsite renewable sources.

HERS Recommendations

Your HERS report will contain detailed recommendations so that you can learn about all the improvements that are cost-effective and appropriate for your particular home. Here are a few examples:

Test and seal air leaks in building envelope

A pressure test will show where the air is leaking out so you can make your home less drafty.



Increase attic insulation to R-38

Properly installed insulation makes your home quieter and more comfortable.



Test and seal air duct leaks

Almost every home in California has leaky ducts, typically wasting 30 percent or more.



Tune-up the heating and cooling system

Proper maintenance saves energy and improves comfort and safety.



Upgrade to a correctly sized ENERGY STAR® furnace

A new ENERGY STAR® furnace will run more quietly and keep you warm all winter for less money.



Hire a Professional

Don't trust just anyone to make your improvements. Trying to save a little can sometimes cost you more in the long run. Instead, find one or more licensed specialty contractors who have the knowledge, tools, and skills to do each job right. You may want to consider a "building performance" contractor who is a licensed general contractor and is specially trained and certified to help address all of the energy and comfort improvement opportunities in your home and make them work together as an efficient system. The Contractors State License Board website www.cslb.ca.gov provides more information on how to choose a qualified contractor.

Making WISE IMPROVEMENTS



Do it Yourself

Some improvements are so easy and inexpensive, you don't need a HERS rating to know they pay back quickly:

- Replace incandescent bulbs with ENERGY STAR® compact fluorescent lamps (CFLs).
- Replace all nightlights and holiday lights with light-emitting diodes (LEDs).
- Choose ENERGY STAR® appliances, computers, and televisions.
- Install low-flow showerheads and faucet aerators.
- Insulate the first 5 feet of pipes from the cold and hot water heater.
- Add or repair weather stripping on all doors and windows.
- Use caulk and spray foam to fill all visible air gaps.
- Clean or replace furnace air filters monthly.
- Plant shade trees.



Energy Wise HABITS

These no-cost tips will help reduce the energy consumption in your home:

- Turn off lights and computers when not in use.
- Use a power strip for televisions, DVD players, VCRs, and chargers, and turn off power to the strip when not in use.
- Recycle burned-out CFL bulbs, fluorescent tubes, televisions, computer monitors, and all other electronic waste.
- Unplug and recycle any inefficient old refrigerators and freezers.
- Use appliances efficiently. Use your dishwasher and clothes washer for full loads only. Use the cold water setting on your clothes washer when possible.
- Turn down the water heater to 120 degrees Fahrenheit.
- Use your drapes properly. In the summer, close your drapes during the day. In the winter, open your drapes during the day and close your drapes at night.
- Open your windows for natural ventilation on cool summer mornings and nights.

A \$100 per month reduction in your utility bills frees up enough cash to pay for a \$17,000 increase in your mortgage (assuming 6 percent interest over 30 years).

Utility Bills & RATINGS

Home energy efficiency ratings are designed to help you focus on the physical features of the house – not on other factors that can affect energy consumption like unusual weather or personal energy use habits.

Utility bills give a personal perspective: the history of how much energy the occupants of the home actually used over a period. Unless you consider a rating coupled with the utility bills, you may get only half of the story.

As a potential buyer, you should always ask to see the previous occupant's energy bills. While sellers are not obligated to share their utility bills, many will if asked.

If the old bills have not been saved, current occupants can access their records by calling the local utility or by setting up an account on the utility's website. Your HERS Rater can assist you in obtaining the bills and will consider them to establish a more complete picture of your home energy use to make the best recommendations for improvements. A Home Buyers' Energy Checklist that helps buyers ask questions related to the home's energy use is available at: www.energy.ca.gov/HERS/index.html.

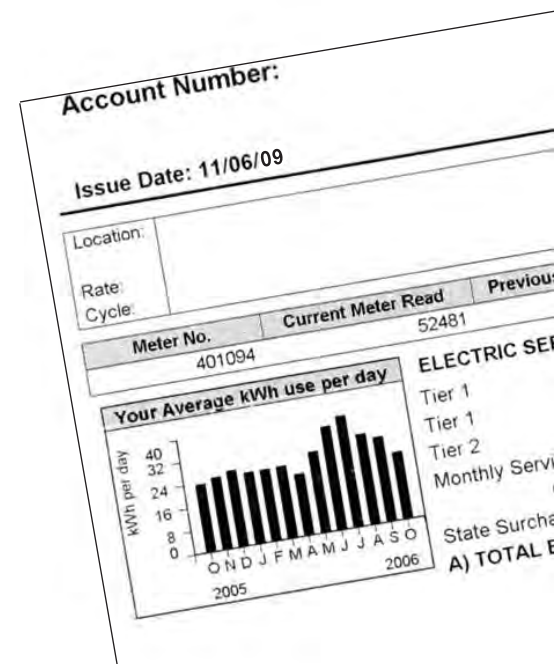

Energy efficiency is different than energy consumption. Efficiency depends upon the physical features of the home and all the equipment it contains. Consumption is reduced through efficiency but also depends on the energy use behavior of the occupants. Wasteful habits, unusual weather, or malfunctioning equipment can drive up energy bills, even in the most energy-efficient house in the neighborhood.

After your mortgage payment, your energy bill is often the second largest monthly home ownership expense.



Financing your
IMPROVEMENTS

Principal
+ **I**nterest
+ **T**axes
+ **I**nsurance
+ **E**nergy

**True cost of owning
your home**

If you are buying or refinancing and looking for a way to finance your energy improvements, you should get advice from a knowledgeable real estate agent or lender about the many new options now available. The federal government, Fannie Mae/Freddie Mac, and many major lenders are introducing new products to help you fund your energy efficiency improvements. Some cities and counties also have programs that allow homeowners to finance efficiency improvements and solar installations over 20 years.

You may also be able to qualify for an Energy Efficient Mortgage (EEM). An EEM is a loan program that recognizes the importance of the energy efficiency of a home and allows for cost-effective energy upgrades to be financed in the mortgage. A HERS rating is required to qualify for an EEM. These loans provide borrowers the opportunity to make energy efficiency improvements to their homes and gain several desirable benefits including:

- Provide the ability to roll the cost of your efficiency improvements into a low mortgage rate.
- May stretch your debt-to-income qualifying ratio.
- Enjoy your improvements and energy savings right away.
- Earn a higher resale price when you sell.

Best of all, you get to enjoy all the benefits of your home improvements for the same total monthly cost (PITI+E)...or maybe even less.

EEM programs are available from:

- Federal Housing Authority (FHA)
- Veterans Administration (VA)
- Conventional lenders (Fannie Mae, Freddie Mac)
- Other home-buyer or refinancing programs

Combine an EEM with other programs and you may be able to borrow up to \$40,000 or more for efficiency improvements. Ask a knowledgeable lender if an EEM is right for you.

Another way to finance energy improvements is through an equity loan or equity line of credit. If your HERS rating is low enough, some lenders may offer a “green” mortgage or equity line of credit at a discount relative to their regular interest rates or points. Shop around to see if these products make sense for you. Utilities also offer financial incentives such as re-bates, for energy smart improvements, such as:

- Added insulation
- ENERGY STAR® appliances
- Refrigerator recycling
- High-efficiency heating and air conditioning systems
- Compact fluorescent light fixtures
- Whole-house fans, cool roofs, swimming pool pump motors, and more

Contact your local utility for information on their program offerings. Manufacturers also offer discounts or rebates on efficient products so check their websites or with a retailer for possible offers.

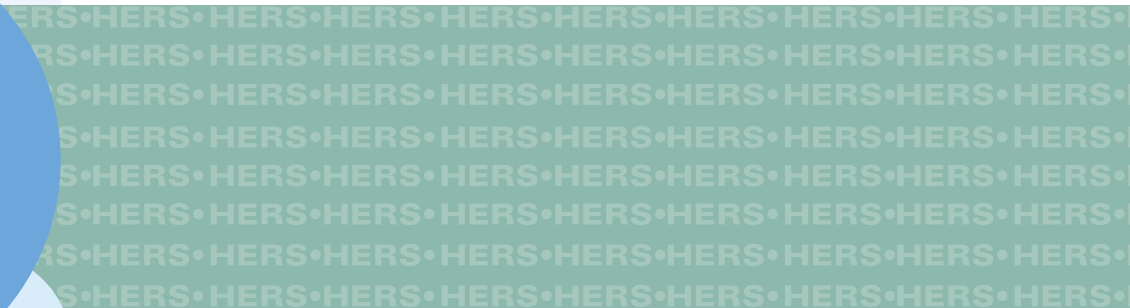



**Efficiency
ADDS VALUE**

It's no secret; energy efficiency features may make your home more valuable and sell faster.

Federal tax credits now available include:

10 percent of the cost, up to \$500 or a specific amount from \$50-\$300, through 2011 (existing homes only) for:

- Windows and Doors
- Biomass Stoves
- Insulation
- Roofs
- HVAC
- Water Heaters

30 percent of the cost, with no upper limit through 2016 (existing homes and new construction) for:

- Geothermal Heat Pumps
- Small Wind Turbines (Residential)
- Solar Energy Systems

For more news on energy efficiency tax credits, visit: www.energystar.gov/taxcredits

Did You Know?

- A study of energy-efficient homes in The Appraisal Journal showed that a \$1 reduction in annual energy bills resulted in more than \$10 increase in resale value.
- A past president of the California Association of Real Estate Appraisers recommends that appraisals account for any efficiency improvements because they "so contribute to the habitability, enjoyability and economic stability of the home."
- FHA authorizes the cost of energy efficiency measures to be added to the mortgage.
- Home builders find that homes with efficiency and solar electricity upgrades sell faster and at higher prices than similar homes nearby.

Make sure your real estate agent knows about any efficiency improvements you have made, let buyers know your home is "Energy-Rated," and give the appraiser a copy of your HERS Report.

The energy used in the average home produces roughly twice as much greenhouse gas pollution as the average car (US EPA).

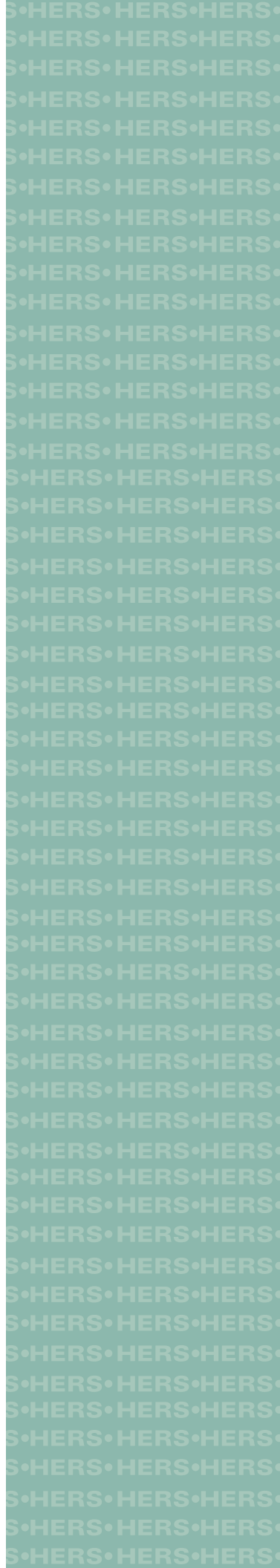

Once you have made all appropriate energy efficiency improvements, you may also want to consider solar electric generation.

If you have already decided on the size of solar electric system, investing in energy efficiency measures first will allow your solar system to power more of your home’s electricity need. Plan ahead and don’t oversize your new solar electric system to power an energy-inefficient house. Your HERS Rater will show you how.

California has set a goal to generate 3,000 megawatts of new, solar-produced electricity by 2017 — moving the state toward a cleaner energy future and lowering the cost of solar systems for all consumers. The California Solar Initiative offers incentives up to 30 percent off the installed cost of a solar system for a typical home. This discount may be combined with any federal tax credits or other incentives available.

Visit
www.gosolarcalifornia.ca.gov
for details.

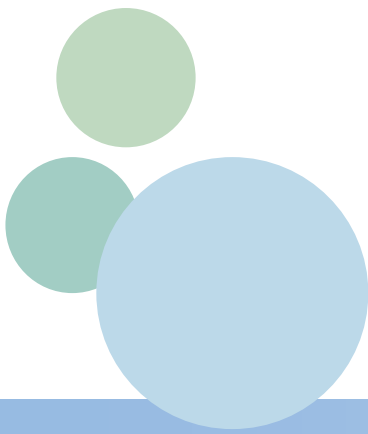

The California Energy Commission does not endorse any product, supplier, manufacturer, builder or organization.

The text in this booklet is designed to be informational and not all-inclusive.



CALIFORNIA
ENERGY COMMISSION

ACKNOWLEDGEMENTS

ADVISORY COMMITTEE

Arlene Baxter	REALTOR®, Berkeley, CA
Mike Bachand	CalCERTS, Inc.
Elizabeth Gavric	California Association of REALTORS®, Government Affairs
Greg Harding	Office of Real Estate Appraisers
Shery Hoellwarth	ConSol, Inc.
Paula B. Howell	Energy Documentation Services
William Jansen	Broker Risk Management
Jana Maddux	CHEERS®
Scott Muldavin	Green Building Finance Consortium; The Mauldavin Company
William Neece	Green Key Real Estate
Chris Neri	California Department of Real Estate
William Poulton	California Real Estate Inspection Association
Randal Riedel	California Building Performance Contractors Association
Charles Segerstrom	Pacific Gas & Electric Company
Bernie Stephan	Broker, Marin County

PROJECT CONSULTANTS

Tom Conlon	GeoPraxis, Inc.
Charles Eley	Architectural Energy Corporation
Margaret Kapranos	REALTOR®, Greenbrae, CA
Dan Suyeyasu	Architectural Energy Corporation
Andrew Waegel	GeoPraxis, Inc.

ADDITIONAL CONTRIBUTORS

Rashid Mir	California Energy Commission
Betty LaFranchi	California Energy Commission
Vanessa Byrd	California Energy Commission
Bruce Maeda	California Energy Commission
Beverly Duffy	California Energy Commission
Parker Scott	California Energy Commission
Lance DeLaura	SEMPRA

Governor

Jerry Brown

Chairman

Robert Weisenmiller, Ph.D.

Vice Chairman

James D. Boyd

Commissioners

Karen Douglas

Carla Peterman

Anthony Eggert

Executive Director

Robert Oglesby

Deputy Director

Efficiency and Renewable

Energy Division

Panama Bartholomy

Office Manager

High Performance Buildings and

Standards Development

Bill Pennington

Project Manager

Helen Lam

California Energy Commission

1516 Ninth Street, MS-37

Sacramento, CA 95814-5512

**Need Help? Call the Energy Hotline
(800) 772-3300 or (916) 654-5106**

CEC-400-2009-008-BR-REV1

June 2011

Prepared by:

Architectural Energy Corporation

San Francisco, California

Contract No. 400-05-020

Photo on page 4 courtesy of The Energy Conservatory.

Photos on page 7 courtesy of: National Renewable Energy Laboratory, CertainTeed, and Carrier.

Property Address:

I have received a copy of the **WHAT IS YOUR HOME ENERGY RATING?** booklet (CEC-400-2009-008-BR-REV1)

Buyer's Signature Printed Name Date

Buyer's Signature Printed Name Date

Buyer's Agent Signature Printed Name Date

Broker's Name

Seller's Signature Printed Name Date

Seller's Signature Printed Name Date

Listing Agent's Signature Printed Name Date

Broker's Name

ALL SIGNERS SHOULD RETAIN A COPY OF THIS PAGE FOR THEIR RECORDS



California Civil Code Section 2079.10 states that if this booklet is provided to the buyer by the seller or broker, then this booklet is deemed to be adequate to inform the home buyer about the existence of California Home Energy Rating Program.

For more information, visit: www.energy.ca.gov/HERS/index.html

Homeowner's Guide to Earthquake Safety



Before Earthquake



Damage from magnitude 6.7 earthquake



Additional damage from aftershocks

2005 Edition



Published by
The California
Seismic Safety
Commission

State of
California
Arnold
Schwarzenegger,
Governor

SSC No. 05-01

This 2005 Edition of the Homeowner's Guide to Earthquake Safety replaces the 2002 Edition on July 1, 2005.



Publishing Information

The Homeowner's Guide to Earthquake Safety was developed and published by the California Seismic Safety Commission. The guide was prepared for publication by the staff of The Collaborative for Disaster Mitigation, San Jose State University, One Washington Square, San Jose, CA 95192-0082. It was distributed under the provisions of the Library Distribution Act and Government Code Section 11096.

Copyrighted 2005 by the California Seismic Safety Commission
All rights reserved

Legislation

This guide has been developed and adopted by the California Seismic Safety Commission as required by Assembly Bill 2959, authored by Assemblyman Johan Klehs (Chapter 1499, Statutes of 1990), and Assembly Bill 200, authored by Assemblyman Dominic Cortese (Chapter 699, Statutes of 1991).

Ordering Information

Copies of this booklet are available from the California Seismic Safety Commission, 1775 Creekside Oaks Drive, Suite 100, Sacramento, CA 95833. To order call (916) 263-5506 or download via our website at <http://www.seismic.ca.gov/sscpub.htm>

On the cover:

Taken in Coalinga, California, the pictures of this single family home show the destruction caused by the Coalinga Earthquake on May 2, 1983. The 6.7 magnitude earthquake inflicted severe damage to the unreinforced masonry porch, forcing the occupants to evacuate. Numerous aftershocks occurred within the next few days, causing portions of the already weakened structure to collapse.

CONTENTS

	<i>Page</i>		<i>Page</i>
INTRODUCTION	1	OTHER EARTHQUAKE-RELATED	
Your Home and the Law.....	2	CONCERNS	28
Recommendations.....	3	Unreinforced Masonry Chimneys.....	28
Summary of Major California Laws.....	4	Foundations.....	30
Property Tax and Insurance.....	5	Homes with Unique Designs.....	31
Examples of Damage to Single Family Homes.....	6	NATURAL GAS	
EARTHQUAKE MAPS OF CALIFORNIA	7	SAFETY	32
Damaging Earthquakes in California.....	7	GETTING THE WORK DONE	34
Major Earthquake Faults in California.....	8	GEOLOGIC	
Simplified Earthquake Shaking Potential Map for California.....	9	HAZARDS	36
ADDITIONAL RESOURCES	10	WHAT TO DO <i>DURING</i> AN	
EARTHQUAKE WEAKNESSES	11	EARTHQUAKE	39
Unbraced Water Heaters.....	12	WHAT TO DO <i>BEFORE</i> AN	
Home Not Anchored to Foundation.....	14	EARTHQUAKE	40
Weak Cripple Walls.....	16	WHAT TO DO <i>AFTER</i> AN	
Pier and Post Foundations.....	18	EARTHQUAKE	42
Unreinforced Masonry Foundations.....	20	RESOURCE ORGANIZATIONS	44
Homes Built on Steep Hillsides.....	22	RESIDENTIAL EARTHQUAKE HAZARDS	
Unreinforced Masonry Walls.....	24	REPORT	47
Rooms over Garages.....	26	SAMPLE TAX EXCLUSION FORM	49

ACKNOWLEDGMENTS

Seismic Safety Commission

Lucille M. Jones, Ph.D., Chair, *Seismology*
Hon. Richard Alarcon, *State Senate*
(Chris Modrzejewski)
Hon. Carol Liu, *State Assembly*
(Donald Manning)
Lawrence T. Klein, *Utilities*
Mark Church, *Local Government*
Linden Nishinaga, P.E., *City Government*
Celestine Palmer, *Insurance*
Andrew A. Adelman, P.E., *Cities/Building*
Official
Stan Moy, A.I.A., *Architecture and Planning*
Daniel Shapiro, S.E., *Structural Engineering*
Vacant, *Mechanical Engineering*
Bruce R. Clark, Ph.D., *Geology*
Vacant, *County Government*
Vacant, *Emergency Services*
Donald R. Parker, Vice Chairman, *Fire*
Protection
Jimmie R. Yee, *Social Services*
Vacant, *Soils Engineering*

Seismic Safety Commission Staff

Richard McCarthy, Executive Director
Robert Anderson
Karen Cogan
Henry Reyes
Henry Sepulveda
Fred Turner, Project Coordinator
Sue Celli
Rebecca Romo

Collaborative for Disaster Mitigation Staff

Guna Selvaduray, Ph.D., Executive Director
Patrick Chong, Webmaster
Crystal Carrera, Administrative Assistant

The Commission gratefully acknowledges the assistance of the following:

American Red Cross
American Society of Home Inspectors
Association of Bay Area Governments
Building Education Center
California Association of Realtors
California Building Officials
California Council of the American Institute of
Architects
California Geological Survey
California Real Estate Inspection Association
California Governor's Office of Emergency
Services
City of Los Angeles
Earthquake Engineering Research Institute
Humboldt Earthquake Education Center
International Code Council
SBC
San Diego Association of Governments
Southern California Association of Governments
Southern California Association of Residential
Retrofit Professions
Southern California Gas Company/Sempra
Structural Engineers Association of California
Committee on Earthquake Safety Issues for Gas
Systems

Disclaimer: The effects, descriptions, recommendations, and suggestions included in this document are intended to improve earthquake preparedness; however, they do not guarantee the safety of an individual or a structure. The Seismic Safety Commission takes responsibility for the inclusion of material in this document. The State of California, the Seismic Safety Commission, and all contributors to this document do not assume liability for any injury, death, property damage, loss of revenue, or any other effect of an earthquake.

INTRODUCTION

Earthquakes, especially major ones, are dangerous, inevitable, and a fact of life in California. Sooner or later another “big one” will occur.

Earthquakes:

- Occur without warning
- Can be deadly and extremely destructive
- Can occur at any time

As a current or potential owner of a home*, you should be very concerned about the potential danger to not only yourselves and your loved ones, but also to your property.

The major threats posed by earthquakes are bodily injuries and property damage, which can be considerable and even catastrophic.

Most of the property damage caused by earthquakes ends up being handled and paid for by the homeowner.

- Earthquakes have caused over \$55 billion in losses in California since 1971.
- Large earthquakes in or near major urban centers in California will disrupt the local economy and can disrupt the economy of the entire State.

However, proper earthquake preparation of your home can:

- Save lives
- Reduce injuries
- Reduce property damage

As a homeowner, you can **significantly reduce** damage to your home by fixing a number of known and common weaknesses.

This Booklet is designed to assist you in filling out the Residential Earthquake Hazards Report (See page 47) when you sell your home.

This booklet is also a good start to begin strengthening your home against earthquake damage.

It describes:

- Common weaknesses that can result in your home being damaged by earthquakes, and
- Steps you can take to correct these weaknesses.

There are no guarantees of safety during earthquakes, but properly constructed and strengthened homes are far less likely to collapse or be damaged during earthquakes. The California Seismic Safety Commission advises you to act on the suggestions outlined in this booklet and make yourself, your family, and your home safer.

*For the purpose of this document, “home” includes single family residences, duplexes, triplexes, and fourplexes.

YOUR HOME AND THE LAW

California State Law requires the seller to:

- Inform the buyer about known home weaknesses (*See Earthquake Weaknesses, beginning on page 11*).
- Strap the water heater, reducing the chance of it falling during an earthquake and possibly causing gas and water lines to break.
- Deliver a copy of this booklet to the buyer if the home was built before 1960 (*Your real estate agent is required to give the seller a copy of this booklet*).
- Deliver to buyers a Natural Hazards Disclosure form (*See page 4*). The disclosure will tell buyers whether the home is in an Earthquake Fault Zone or in a Seismic Hazard Zone (*See page 38*).
- Complete the *Residential Earthquake Hazards Report*, to be provided to the buyer (*See page 47*).

California State Law does not require the seller to:

- Hire someone to evaluate your home.
- Strengthen your home before selling it.

This Booklet:

- Describes the most common weaknesses that can cause damage to homes, in the event of an earthquake.
- Enables the seller to meet the State Law requiring this booklet be given to every buyer of homes built before 1960.
- Enables the seller to disclose to the buyer the typical earthquake weaknesses in homes built before 1960.
- Provides the homeowner with basic information about finding and fixing earthquake-related weaknesses in the home.
- Provides general information about earthquake risks and directions for finding more information on earthquake safety.

RECOMMENDATIONS...

If You Are Selling

Before you sell your house, the following steps are recommended:

- If you list your house for sale through a real estate broker or agent, give the agent the completed disclosure form (See page 47) as soon as practical. Your agent can give the booklet and the form to the buyer for you.
- You are not required to hire someone to answer the questions on the disclosure form.
- You are not required to remove siding, drywall, or plaster to answer the questions.
- You are not required to fix the weaknesses before you sell your home.
- However, if you wish, you may get assistance from a certified home inspector, or a licensed contractor, architect, or engineer.
- Keep a copy of the form, signed by the buyer, as evidence that you have complied with the earthquake disclosure requirement.

You may find that you will get a better price for your house if you strengthen earthquake weaknesses before you sell.

If You Are Buying

Before you agree to buy a house, consider the following recommendations:

- Have a certified home inspector, licensed building contractor, architect, or engineer inspect the house and give you an opinion regarding existing earthquake weaknesses and an estimate of costs to strengthen these weaknesses.
- Consider the location of the home: Is it in or near an Earthquake Fault Zone or in an area where it might be damaged by a landslide, liquefaction, or a tsunami? You may wish to hire a licensed geotechnical engineer and/or engineering geologist to check the stability of the land under the house.
- Negotiate the cost of strengthening, if any is required, with the seller. The law does not require either you or the seller to strengthen the home, but if these weaknesses are not fixed, you may find that repair costs after a damaging earthquake can amount to more than your equity in the house.





SUMMARY OF MAJOR CALIFORNIA LAWS RELATED TO SEISMIC SAFETY

Full wording of all California codes is available at: <http://www.leginfo.ca.gov>.

Delivering this guide

Sellers of homes built before 1960, with one to four units of conventional light-frame construction, must deliver to the buyer, “as soon as practicable before the transfer,” a copy of *The Homeowner’s Guide to Earthquake Safety* (this booklet) and disclose certain earthquake deficiencies according to *Government Code*, Section 8897.1 to 8897.4. The seller’s real estate agent must provide the seller with a copy of this booklet to give to the buyer. This is also specified in *Government Code*, Section 8897.5.

Water heater bracing

All water heaters are required to be anchored or strapped to resist falling during an earthquake. The seller must certify to the potential buyer that the water heater is properly braced in accordance with *Health and Safety Code*, Section 19211.

Disclosing weaknesses

Sellers of real property must disclose known defects and deficiencies in the property—including earthquake weaknesses and hazards—to prospective buyers in accordance with *Civil Code*, Section 1102 and following sections.

Disclosing natural hazards

Sellers of real property must disclose whether the property is within any of the seven mapped natural hazard areas, including the earthquake fault, potential landslide and potential liquefaction areas. The required Natural Hazards Disclosure Form can

be found in *Civil Code*, Section 1103 and following sections. When filled out, this statutory form will reveal whether the home is within a mapped geologic, flood or hazard area.

Earthquake faults

The Alquist-Priolo Earthquake Fault Zoning Act prohibits building for human occupancy astride active faults. *Public Resources Code*, Section 2621 and following sections, requires sellers of existing residences to disclose to potential buyers on a Natural Hazards Disclosure Form if the property is located in a designated fault zone.

Landslide and liquefaction

The Seismic Hazards Mapping Act requires the state to prepare maps of the zones in California most susceptible to landslide and liquefaction hazards during earthquakes. *Public Resources Code*, Section 2694 and following sections, states that sellers must disclose to buyers, on a Natural Hazards Disclosure Form, whether the property is in such a zone, after the map for that area has been issued officially.

Publishing this guide

The Seismic Safety Commission is required to develop, adopt, update, and publish *The Homeowner’s Guide to Earthquake Safety* containing information on geologic and seismic hazards, explanations of structural and nonstructural earthquake hazards, and recommendations for mitigating these hazards, as required by the *Business and Professions Code*, Section 10149.

PROPERTY TAX AND INSURANCE

Property Tax Reappraisal Exclusion

California law allows homeowners to strengthen their homes with approved seismic strengthening techniques without the improvement being included in reappraisals that usually raise the property value and the tax owed, according to the *Revenue and Tax Code*, Section 74.5.

If you make an addition, such as a swimming pool or a new den to your home, your property tax bill will increase. But a strengthening project to help your home resist earthquakes will not add to your property taxes.

To receive the exclusion you must file a claim form with your county assessor. The work must also be approved as appropriate seismic strengthening by your local building department.

A sample form from the County of Santa Clara is attached on page 49. This form may vary by county.

Earthquake Insurance

Earthquake insurance is typically not part of your homeowner insurance policy. All insurance companies that sell residential property insurance in California are required by law to offer earthquake insurance to homeowners when the policy is first sold and every two years afterward.

The cost of the earthquake policy you are offered is based on a number of factors, including your home's location, age, construction type, and value. One thing to consider would be to compare the expected damage versus the deductible that is applicable to your policy. You may wish to consult a licensed civil or structural engineer for more specific information on your potential for damage.

Each homeowner should consider his/her individual risk factors and then weigh the cost of earthquake coverage against the benefits. The California Earthquake Authority (CEA) website has an online calculator to help estimate your premium based on your ZIP Code, insured value, dwelling type, and desired coverage and deductible.

The California Earthquake Authority is required to provide, and the insurance companies are required to disclose the availability of, discounts on earthquake insurance premiums for older homes that have been strengthened to resist earthquake damage. For more information, contact your insurance agent, who can also help you locate an earthquake insurer and estimate your annual premium.

California Earthquake Authority:
www.EarthquakeAuthority.com

California Department of Insurance:
www.insurance.ca.gov

EXAMPLES OF DAMAGE TO SINGLE FAMILY HOMES



Pacific Fire Rating Bureau

Figure 1 - San Fernando Earthquake, Feb. 9, 1971 Severely damaged split level 1 and 2 story wood frame dwelling. The one story portion dropped about 3 feet.



FEMA News Photo

Figure 4 - Northridge Earthquake, Jan. 17, 1994 Chimney Collapse - common type of damage to unreinforced masonry.



Robert A. Eplett, OES

Figure 2 - Loma Prieta Earthquake, Oct. 17, 1989 Home moved off of its foundation and was considered a total loss.



Dane Golden, FEMA News Photo

Figure 5 - San Simeon Earthquake, Dec. 22, 2003 This home slid two feet off its foundation due to inadequate nailing of walls to its sill plates.



FEMA

Figure 3 - Northridge Earthquake, Jan. 17, 1994 Single family residence damaged due to failure of multiple elements.



Gina Salvaduray

Figure 6 - San Simeon Earthquake, Dec. 22, 2003 The collapsed porch was not adequately attached to this single family residence.

EARTHQUAKE MAPS OF CALIFORNIA

DAMAGING EARTHQUAKES IN CALIFORNIA

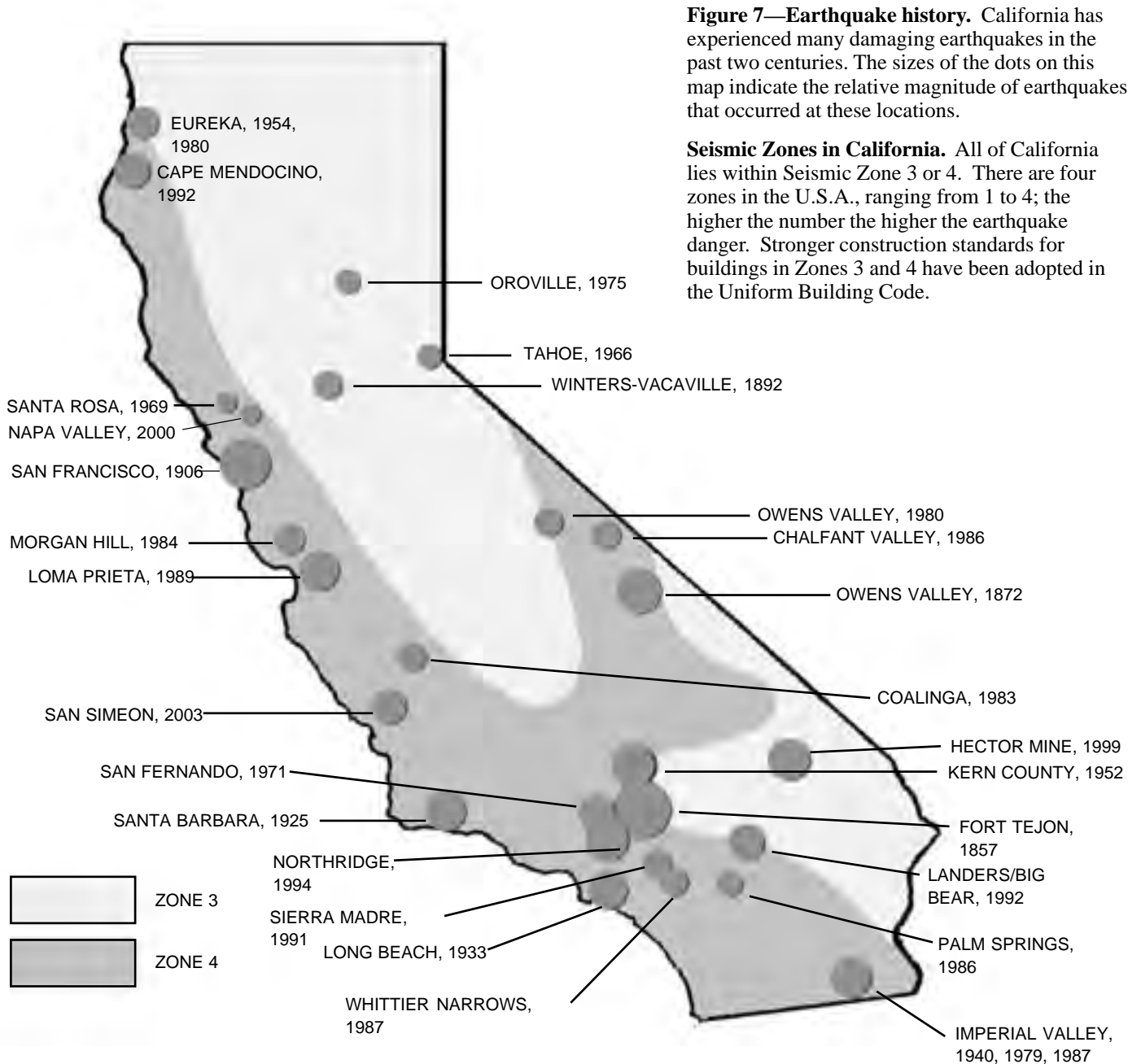

Source: California Geological Survey, 1986; Earthquake History of the U.S., U.S. Department of Commerce and Interior, 1982; Records of California Office of Emergency Services; compiled and revised by California Seismic Safety Commission, 2004; International Code Council, Uniform Building Code 1997 Edition.

MAJOR EARTHQUAKE FAULTS IN CALIFORNIA

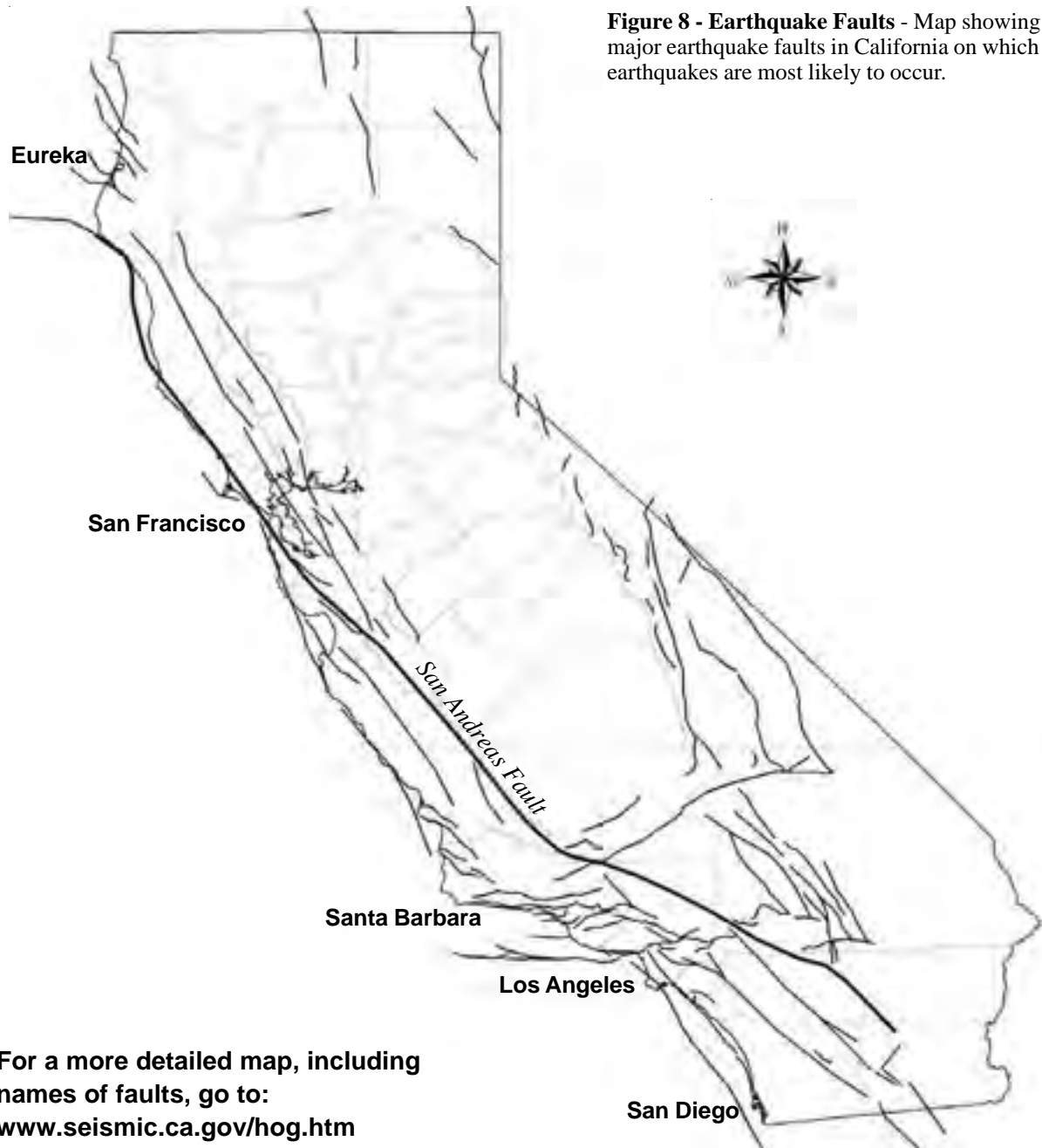

Map courtesy of California Geological Survey. Fault locations modified from seismic sources used in Revised 2002 California Probabilistic Seismic Hazard Maps.

SIMPLIFIED EARTHQUAKE SHAKING POTENTIAL MAP FOR CALIFORNIA

Figure 9 - Earthquake Shaking Potential Map - This map shows the relative intensity of ground shaking and damage in California from anticipated future earthquakes.

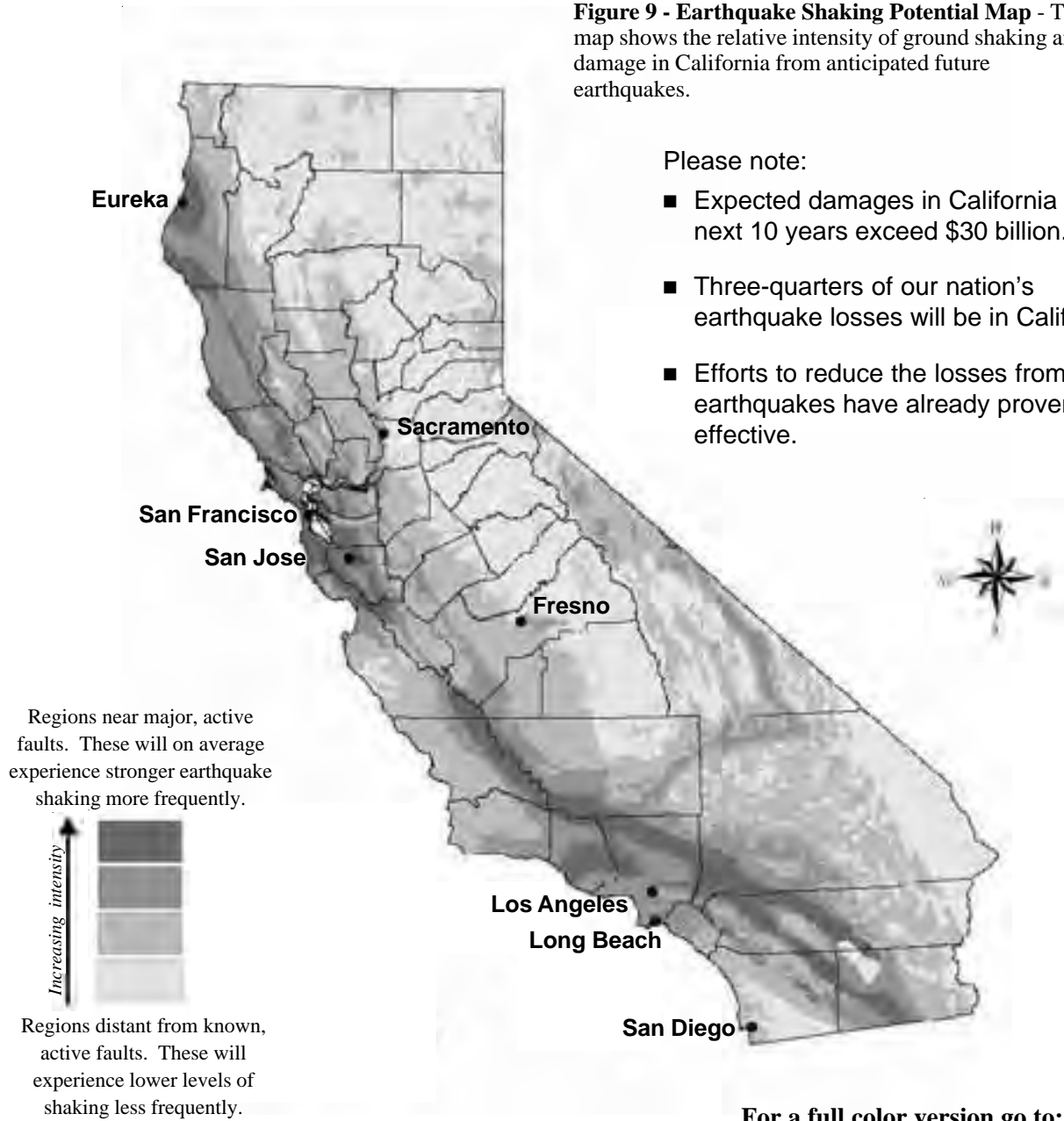

Please note:

- Expected damages in California in the next 10 years exceed \$30 billion.
- Three-quarters of our nation's earthquake losses will be in California.
- Efforts to reduce the losses from earthquakes have already proven effective.

**For a full color version go to:
www.seismic.ca.gov/hog.htm**

Data source: California Seismic Safety Commission, California Geological Survey, Governor's Office of Emergency Services, and United States Geological Survey, April, 2003, Earthquake Shaking Potential for California, California Seismic Safety Commission Publication No. 03-02.

ADDITIONAL RESOURCES

There are many additional resources available. Some are web sites and some are books or pamphlets.

- The California Seismic Safety Commission has created a webpage that provides links to other sites that are appropriate for homeowners interested in improving the earthquake safety of their homes.

Visit www.seismic.ca.gov/hog.htm

- FEMA also provides a wide variety of information suitable for the homeowner, including the availability of, and registration for, federal disaster aid programs after a damaging earthquake or other disasters.

Visit www.fema.gov

EARTHQUAKE WEAKNESSES

The earthquake weaknesses identified in this section, if not corrected, can result in one or more of the following:

- Injury to occupants
- Severe damage to your home
- Broken gas and utility lines
- Fires from broken gas lines
- Damage to floors, walls, and windows
- Damage to the contents in the house
- Damage to the foundations



Please remember that:

- Retrofitting before an earthquake is relatively cheap.
- Doing major structural repairs to your home after an earthquake is very expensive.
- Sometimes the damage is extensive enough to require the entire house to be demolished.
- After an earthquake, there is usually a shortage of available licensed contractors and engineers in the impacted area, because of the sudden high demand for their services.
- An appropriate seismic retrofit will reduce damage and save you money.

Please consult your local Building Department and/or a licensed architect or engineer for more detailed information.

The Problem

If water heaters are not properly braced, they can topple over during an earthquake causing:

- Broken gas lines and gas leaks
- Fires causing major damage to homes
- Broken water lines and flooding

How to Identify

- ✓ Is the water heater free-standing?
- ✓ Are there straps or other types of restraints securing the water heater?
- ✓ Are there straps or restraints bolted to the studs?
- ✓ Are there flexible pipes for water and gas connected to the water heater?

Remember

- Replacing a water heater after an earthquake can cost more than \$500.
- Repairing fire damage and flooding damage can cost several thousand dollars, including the entire cost of your home!
- There are many different ways of strapping a water heater. One example is shown on the next page. (See page 13)
- Check with your local Building Department for details of local requirements.
- Know where your main water valve is so that you can shut it off if you have a water leak.
- Know where your main gas valve is so that you can shut it off if you hear or smell a gas leak. (See page 32)

Water heater



Governor's Office of Emergency Services

Figure 10 - The unbraced water heater in this home fell during an earthquake; the resulting fire destroyed the home.



Gina Salvaduray

Figure 11 - This unstrapped water heater tipped over during the 1984 Morgan Hill Earthquake. Fortunately gas and water lines were not ruptured.

Water heaters must be braced (securely attached) to the studs in a wall. California law requires water heaters to be braced at the time of sale, or when a new water heater is installed.

The Solution

There are many solutions – all relatively inexpensive.

- Purchase and install a strap kit or bracing kit from your local hardware store. Be sure the kit is certified by the State Architect.

Other options include:

- Have a licensed plumber strap your water heater according to code.
- Use metal tubing or heavy metal strapping and lag screws and washers to secure the water heater to the wall studs.

The gas and water lines should also have flexible pipes. These are safer than rigid pipes during an earthquake.

Be sure to check the straps once a year. They may come loose due to vibrations, or other causes.

How-to Resources

- Your local home improvement store
- [How to Brace Your Water Heater](#), City of Los Angeles, Department of Building & Safety, Information Bulletin #P/PC 2002-003, June 14, 1999.
- [Guidelines for Earthquake Bracing of Residential Water Heaters](#), Department of General Services, Division of State Architect, August 11, 2004.
- [How to Secure Your Water Heater](#), Governor’s Office of Emergency Services, 2003.

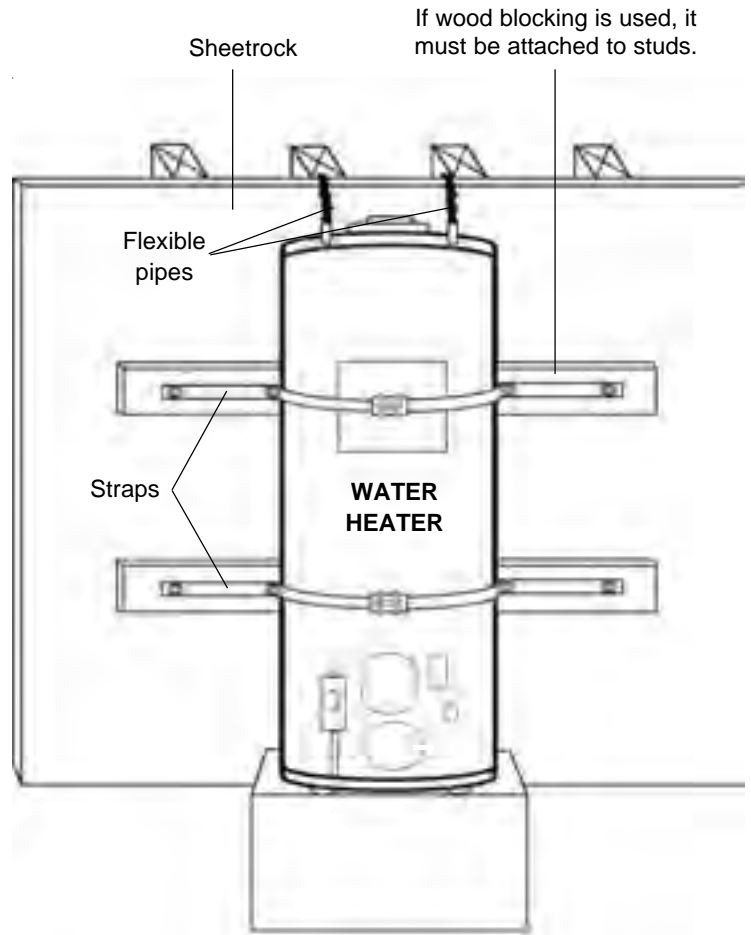

Figure 12: One Method of Water Heater Bracing. Straps and screws visible with water heater in a garage installation. You may need to add wood blocking.

Comparison of Cost: Preventing vs. Repairing Earthquake Damage	
Project Cost	Cost to Repair after an Earthquake
\$20 to \$200	\$500 to total value of home (if completely destroyed).

The Problem

Houses that are not bolted to the foundation can move off their foundations during earthquakes.

How to Identify

- ✓ Go down into the crawl space – the area between the first floor and the foundation – to find out if your house is bolted to its foundation.
- ✓ Look for the heads of anchor bolts that fasten the sill plate – the wooden board that sits directly on top of the foundation – securely to the foundation. (See Figure 14a, page 15)
- ✓ You should be able to see the large nuts, washers, and anchor bolts, installed at least every 4 to 6 feet along the sill plate. Steel plates are sometimes used instead of anchor bolts. (See Figure 14b, page 15)

Remember

- It is very expensive to lift a house, and place it back on its foundation.
- Homes moving off their foundations can cause gas lines to rupture, which in turn can result in fires.



Office of Emergency Services

Figure 13 - This home wasn't bolted and slid off its foundation. Sometimes the damage can be so bad that houses have to be demolished.

If your home has no foundation, or an old concrete foundation, see page 30.

Slab Foundations

Some homes are built directly on concrete slabs. These houses do not have crawl spaces and cripple walls.

Nearly all homes with slab foundations that were originally built to code will have anchor bolts or straps.

However, if the house is not bolted to the slab, you have an earthquake weakness.

Newer homes generally have anchor bolts or straps.

If you have an unfinished garage, you may be able to see the anchor bolts.

You are not required to remove siding, drywall or plaster to determine if your house has anchor bolts.

The Solution

Drill holes through the sill plate into the foundation and install anchor bolts. (See Figure 14a)

If there is not enough room to drill, you can attach steel plates to hold the sill plate to the foundation. (See Figure 14b)

Anchor bolts have to be installed properly for them to be effective.

You must obtain the proper permits from your local Building Department before beginning work.

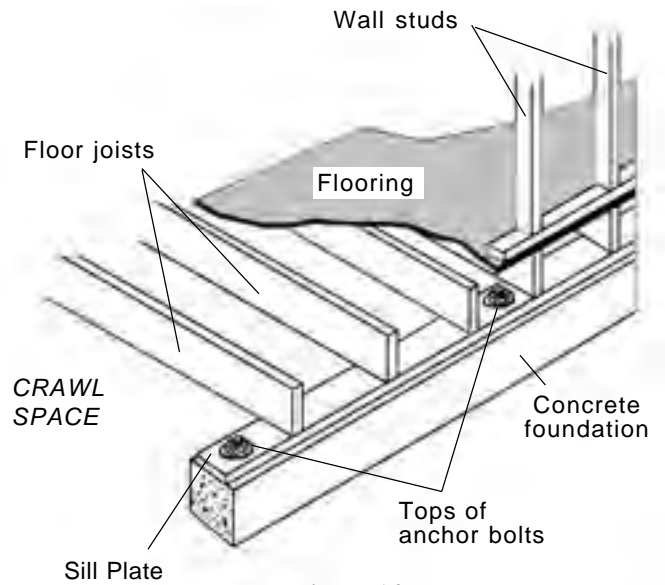

Figure 14a

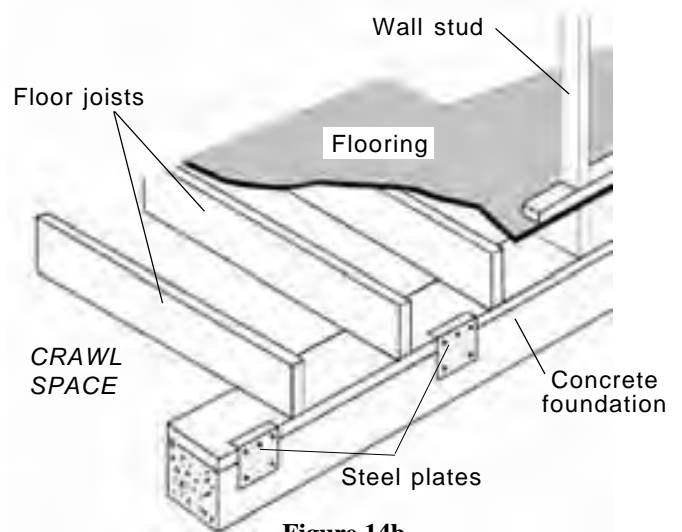

Figure 14b

Figure 14 —Anchor bolts or steel plates. A home’s crawl space may be formed by a cripple wall (see next page for description) between the foundation and the floor joists or the floor joists may rest directly on the sill plate. In either case, you should be able to see the heads of anchor bolts or steel plates installed at appropriate intervals. These fixtures fasten the sill plate to the foundation.

How-to Resources

- Detailed information for do-it-yourselfers or engineers can be found in the [International Existing Building Code](#), published by the International Code Council.
- Publication: [How You Can Strengthen Your Home for the Next Big Earthquake in the Los Angeles Area](#), City of Los Angeles, Department of Building & Safety, October 2001.

Comparison of Cost: Preventing vs. Repairing Earthquake Damage	
Project Cost	Cost to Repair after an Earthquake
\$250 to \$5,000	\$25,000 to total value of home (if completely destroyed).

The Problem

Wooden floors and stud walls are sometimes built on top of an exterior foundation to support a house and create a crawl space. (See Figure 17, page 17)

These are called cripple walls and they carry the weight of the house.

During an earthquake, these walls can collapse if they are not braced to resist horizontal movement.

If the cripple wall fails, the house may shift or fall.

How to Identify

- ✓ Go under the house through the crawl space, to see if there are any cripple walls.
- ✓ If there are cripple walls, check to see if they are braced.
- ✓ There should be plywood panels adequately nailed to the studs OR there should be diagonal wood sheathing. (See Figure 16)
- ✓ If you have neither of these, the cripple walls are probably insufficiently braced or unbraced.
- ✓ Horizontal or vertical wood siding is not strong enough to brace cripple walls.

Remember

- It is very expensive to lift a house, repair the cripple wall, and put it back on its foundation



Office of Emergency Services

Figure 15 - Damage to home due to cripple wall failure.

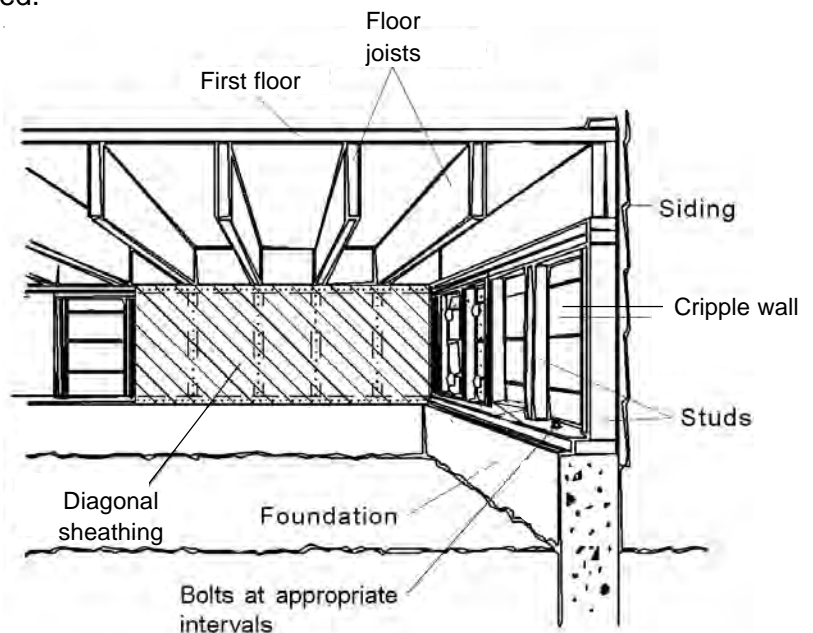

Figure 16 - Diagonal Sheathing. Common in older homes.

The Solution

Plywood, or other wood products allowed by code, should be nailed to the studs.

The following are important:

- Type of wood product used
- Plywood thickness
- Nail size and spacing
- Do not cover vents.

Consult your local Building Department for permit requirements before starting work.

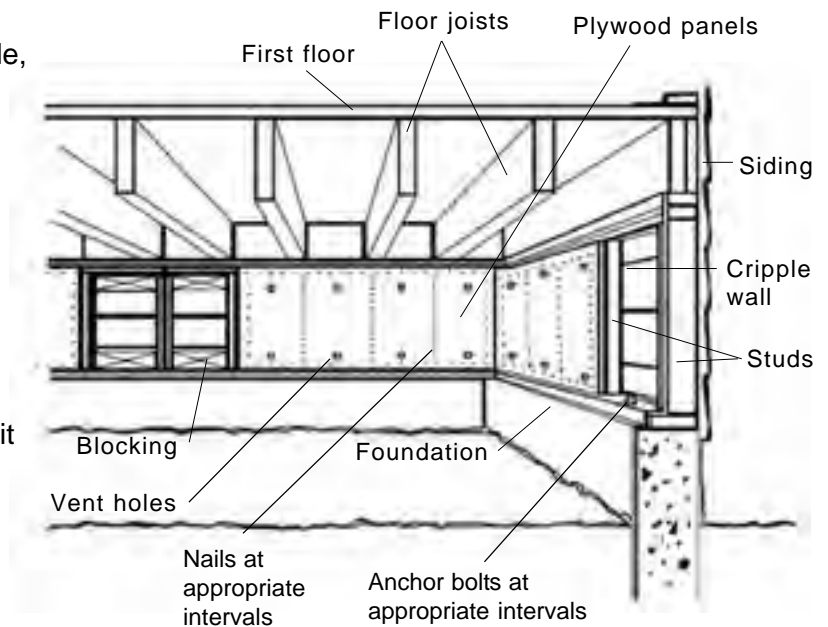
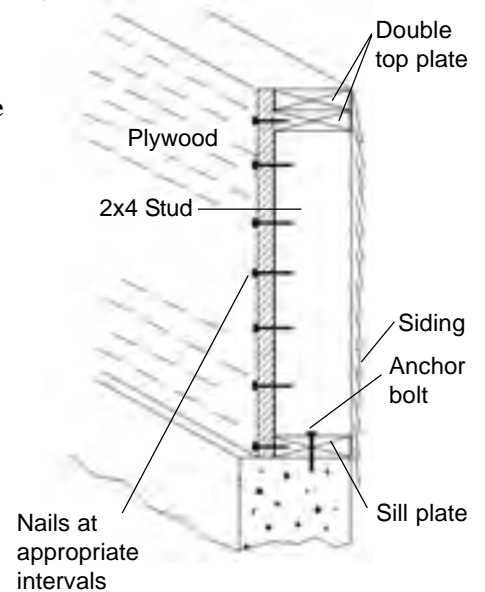

Figure 17—Plywood or diagonal sheathing strengthens weak cripple walls. If your home has a cripple wall between the foundation and the first floor, and the wall is not braced with plywood or diagonal sheathing, the house may fall or shift off its foundation during an earthquake.



How-to Resources

- Detailed information for do-it-yourselfers or engineers can be found in the International Existing Building Code, published by the International Code Council
- Publication: How You Can Strengthen Your Home for the Next Big Earthquake in the Los Angeles Area, City of Los Angeles, Department of Building & Safety, October 2001.

Comparison of Cost: Preventing vs. Repairing Earthquake Damage	
Project Cost	Cost to Repair after an Earthquake
\$500 to \$2,500	\$25,000 to total value of home (if completely destroyed).

The Problem

The outside of the house is supported by wood posts resting on unconnected concrete piers. Siding is often nailed to the outside of the posts, making them not easily visible.

During an earthquake these posts can fail, if they are not braced against swaying.

If the posts fail, the house may shift or fall.

How to Identify

- ✓ Go under the house to see if there is a continuous foundation under the outside walls.
- ✓ If you do not see a continuous foundation you may have an earthquake weakness.
- ✓ If you see only unconnected concrete piers and wood posts, or only wood posts, supporting the outside walls, you have an earthquake weakness.

Remember

- Horizontal or vertical wood siding is not strong enough to brace pier-and-post foundations.
- Major structural repairs, like lifting an entire house to repair the posts and putting it back, are very expensive.



California Seismic Safety Commission



California Seismic Safety Commission

Figure 18 - The pier-and-post foundation under this home shifted during a recent earthquake.

The Solution

Consult a licensed architect or engineer, and a licensed building contractor who specializes in foundations, to fix this problem.

It may be possible to make the foundation safer by bracing the posts.

You might be better off to add a new foundation and plywood walls in the crawl space to make sure that the house will not shift or fall off its foundation during an earthquake.

How-to Resource

- Detailed information for engineers can be found in the [International Existing Building Code](#), published by the International Code Council.

Comparison of Cost: Preventing vs. Repairing Earthquake Damage	
Project Cost	Cost to Repair after an Earthquake
\$1,000 to \$25,000	\$20,000 to total value of home (if completely destroyed).

The Problem

Unreinforced masonry—brick, concrete block, or stone—foundations often cannot resist earthquake shaking. They may break apart, or be too weak to hold anchor bolts. Homes may shift off such foundations during earthquakes, damaging the walls, floors, utility lines, and home contents.

How to Identify

- ✓ If your home's foundation is brick or stone, and looks like one of the foundations shown in the photos here, it is probably unreinforced.
- ✓ If there is a space filled with grout between the inner and outer faces of a brick foundation (where anchor bolts and reinforcing steel could be installed), it may be reinforced.
- ✓ If the outside of the foundation is covered, you may have to look under the house to see the type of foundation you have.
- ✓ If you are not sure what to look for, seek the services of a licensed engineer to determine if your foundation is reinforced or not.

Remember

- It is cheaper to do this before an earthquake damages the house than after.



California Seismic Safety Commission

Figure 19 - This is an unreinforced stone foundation. They typically fail during earthquakes.



California Seismic Safety Commission

Figure 20 - Note the bricks exposed in this unreinforced masonry foundation.

The Solution

There are several ways to fix this problem.

The most common approach is to replace all or part of the existing foundation with a poured reinforced concrete foundation.

Another solution is strengthening the unreinforced brick or stone foundation, which is generally expensive.

Seek the help of a licensed architect or engineer, and a licensed foundation contractor or general contractor.

How-to Resource

- Detailed information for engineers can be found in the [International Existing Building Code](#), published by the International Code Council.

Comparison of Cost: Preventing vs. Repairing Earthquake Damage	
Project Cost	Cost to Repair after an Earthquake
\$15,000 to \$50,000	\$15,000 to total value of home (if completely destroyed).

The Problem

Houses built on the sides of steep hills are often set on exposed posts or columns, as shown in the photographs.

The potentially hazardous conditions that are unique to homes on steep hillsides are:

- Stilt-type posts with or without diagonal bracing
- Walls with very different heights or that are stepped or sloped down the hillsides.

If these posts or walls are not properly braced, they may collapse during an earthquake.

Sometimes, the supports on the downhill side will be hidden behind a tall wall that encloses a large unfinished space. (This is similar to, but taller than, a crawl space under a typical house built on flat ground.)

How to Identify

- ✓ Is the house located on a slope?
- ✓ Are the columns or walls supporting the home braced?
- ✓ If you are not sure if there is bracing or if the bracing is adequate, consult a licensed engineer.

Remember

- It is very expensive to lift a house, repair the posts, and put it back.



Figure 22 - This hillside home was built on an unbraced tall wall that failed.



Figure 23 - This photograph shows an interior detail of a home similar to the one above, showing substantial damage to a building with an unbraced tall wall.

The Solution

Consult a licensed architect or engineer, and a licensed contractor, to fix this problem.



Figure 24 - Hillside homes with sloped and tall walls or posts require special engineering.

How-to Resources

- Detailed information can be found in the [International Existing Building Code](#), published by the International Code Council.
- [Voluntary Earthquake Hazard Reduction in Existing Hillside Buildings](#), City of Los Angeles Municipal Code, Chapter IX, Article 1, Division 94.

Comparison of Cost: Preventing vs. Repairing Earthquake Damage	
Project Cost	Cost to Repair after an Earthquake
\$1,000 to \$50,000	\$10,000 to total value of home (if completely destroyed).

The Problem

Houses built of unreinforced masonry – bricks, hollow clay tiles, stone, concrete blocks, or adobe – are very likely to be damaged during earthquakes.

The mortar holding the masonry together is generally not strong enough to resist earthquake forces.

Anchorage of walls to the floor and the roof is critical.

These houses are weak (brittle) and can break apart.

Walls may fall away or buckle, resulting in damage.

How to Identify

- ✓ Can bricks or stone be seen from the outside (unless the walls are covered with stucco)?
- ✓ Do the brick walls have “header courses” of bricks turned endways every five or six rows? (See Figure 26)
- ✓ Was the house built before 1940?

If you cannot tell from the outside, turn off the power and take the cover plate off one of the electrical outlet boxes on an outside wall and look for brick or other masonry.

If the wall is concrete or concrete block, it is very difficult to find out if reinforcing steel was added during construction.

You will then need:

- The house’s plans, which may be on file with the Building Department, or



California Seismic Safety Commission

Figure 25 - The plaster-covered brick walls of this building collapsed during a recent earthquake.

Figure 26 - Header courses of bricks are usually placed endwise every six or so rows in unreinforced masonry walls to tie the outer layer of bricks to the layers inside the wall.

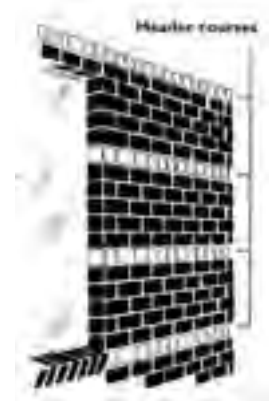

California Seismic Safety Commission

- To consult a licensed engineer to make the determination.

Remember

- It is very expensive to shore up a house, remove damaged walls, and put in new walls.

The Solution

Consult a licensed architect or engineer to fix this problem.

One solution may involve:

- Tying the walls to the floor and roof
- Installing a steel frame and bolting the wall to it.



Jessica Tran

Figure 27 - Unreinforced masonry wall strengthened by installing a steel frame inside.



Jessica Tran

Figure 28 - Bolting of unreinforced masonry wall to steel frame on the inside.

How-to Resource

- Detailed information can be found in the [International Existing Building Code](#), published by the International Code Council.

Comparison of Cost: Preventing vs. Repairing Earthquake Damage	
Project Cost	Cost to Repair after an Earthquake
Project and Repair costs can vary widely.	

The Problem

The large opening of a garage door and the weight of a second-story room built over the garage can result in the walls being too weak to withstand earthquake shaking.

When the narrow sections of the wall on each side of the opening are not reinforced or braced, the weakness is worse.

How to Identify

- ✓ Is the garage door opening in line with the rest of the house? (See Figure 30)
 - If this is the case, additional bracing **may not** be needed.
- ✓ Is the house shaped like Figure 31? If this is the case, are there braces or plywood panels around the garage door opening?
 - If there are no braces or plywood panels, strengthening may be needed.
- ✓ Consult a licensed architect or engineer to determine the strengthening required.

Remember

- Many homes with this weakness have been severely damaged in past earthquakes.



Office of Emergency Services

Figure 29 - This mountain home was built over a garage, and its walls were not strong enough to withstand an earthquake.

HOUSE VIEWED FROM ABOVE

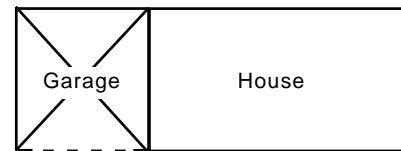
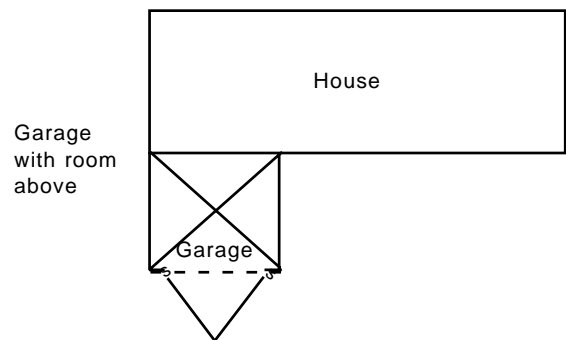

Figure 30 - If the wall of the main house is in line with the wall containing the door of a garage with a room over it, the adjoining wall may help brace the garage.

HOUSE VIEWED FROM ABOVE



Wall may need bracing

Figure 31—Additional bracing. Home configuration where there is no in-line wall. Additional bracing may be appropriate in this situation.

The Solution

Consult a licensed architect or engineer to design plywood paneling or a steel frame around the door opening (See Figure 32).

Have plans drawn.

Obtain a permit from your local Building Department.

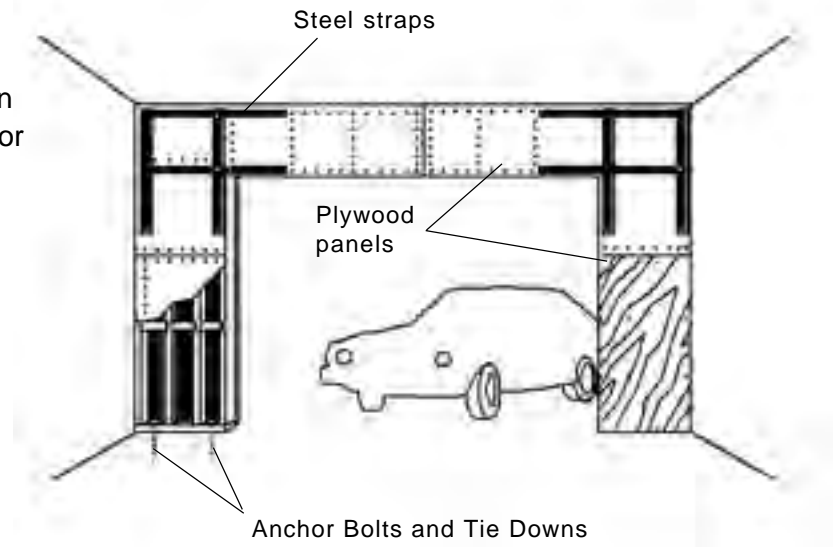

Figure 32—Bracing garage walls. If your house has a room over the garage, the garage walls may not be strong enough to hold up during an earthquake unless they are braced with plywood panels and steel straps.

How-to Resource

- Detailed information can be found in the [International Existing Building Code](#), published by the International Code Council.

Comparison of Cost: Preventing vs. Repairing Earthquake Damage	
Project Cost	Cost to Repair after an Earthquake
\$5,000 to \$25,000	\$15,000 to total value of home (if completely destroyed).

OTHER EARTHQUAKE-RELATED CONCERNS

OTHER CONCERNS

Unreinforced Masonry Chimneys

The Problem

Many chimneys are built of unreinforced brick or stone. During an earthquake these can collapse or break and fall on the roof.

When the chimney fails, the falling stones and bricks can:

- Cause injuries
- Damage the house
- Damage cars

Tall slender chimneys are most vulnerable.

How to Identify

- ✓ Check the mortar between the bricks or stones with a screwdriver. If it crumbles when you pick at it, the chimney may be a hazard.
- ✓ Inspect the attic and floor spaces for metal ties that should be holding the chimney to the house.
- ✓ Determining whether a chimney is susceptible to earthquake damage is not always easy. When in doubt, consult a licensed engineer or contractor.

Remember

- Do not locate patios, children's play areas, or parking spaces near a questionable chimney.
- Tell family members to get away from chimneys and fireplaces during earthquakes.



Office of Emergency Services

Figure 33 - This unreinforced chimney fell during a recent earthquake.



Guna Selvadurai

Figure 34 - Morgan Hill Earthquake. Broken chimney fell on roof.

The Solution

Tear down the old or damaged chimney and replace with a newly constructed chimney.

Several steps can be taken to reduce the risk of damage from falling chimneys, depending upon the type of chimney you have. They include:

- Add plywood panels at the roof or above the ceiling joists to prevent the brick or stone from falling into the house.
 - This can be done by layering plywood above the ceiling, in the house’s attic, or nailing plywood under the shingles when reroofing.
- Replace the upper chimney with metal flues.
- Strengthen the existing chimney.
 - This can be a complicated process, depending upon the construction and height of the existing chimney.

Consult your local Building Department and obtain necessary permits first.

How-to Resource

- [Reconstruction and Replacement of Earthquake Damaged Masonry Chimneys](#), City of Los Angeles, Department of Building & Safety, Information Bulletin #P/BC-2002-70.



Figure 35 - Photo showing damaged chimney removed. Note that the fireplace is now not functional.

Comparison of Cost: Preventing vs. Repairing Earthquake Damage	
Project Cost	Cost to Repair after an Earthquake
\$2,000 to \$12,000	\$15,000 to total value of home (if completely destroyed).

No Foundation

- The Problem** Some older houses were built on wood beams laid directly on the ground, without foundations. These houses may shift during earthquakes, causing structural damage and breaking utility lines.
- How to Identify** Look under the house. If you see no concrete or masonry around the outside walls, the house may lack a foundation.
- What Can Be Done** You may need to add a foundation to make the house earthquake resistant. Just as when strengthening or replacing an unreinforced masonry foundation, you will require the advice of a licensed architect, engineer, or foundation contractor.

Old Concrete Foundation

- The Problem** Some older concrete foundations were made with sand or stone that interacted chemically over time, and the concrete eventually crumbles and becomes too soft to withstand earthquake forces.
- How to Identify** Inspect the foundation for large cracks in the concrete, concrete crumbling off the foundation, or concrete crumbling when you pick at it with a screwdriver.
- What Can Be Done** You may need to replace some or all of the foundation. You should consult a licensed foundation contractor or an engineer.

- The Problem** The design and construction features of some homes make them vulnerable to earthquake damage, especially if these homes are not specifically designed and built to resist earthquakes. Homes at risk are those with irregular shapes, large windows (which can break in earthquakes and scatter shards of glass), more than two stories, irregular walls, or porches and overhangs.
- How to Identify** Many homes with these features are strong enough to withstand earthquakes and it is difficult to tell whether such homes need strengthening. If you have doubts about one or more of these features in your home, or in a home you are planning to buy, you should consult a licensed architect or engineer for an assessment.
- What Can Be Done** A professional can advise you on how to identify and fix earthquake weaknesses if necessary. For example, large windows can be made safer by applying plastic film on them.

NATURAL GAS SAFETY

The Problem

Natural gas piping and appliances can be damaged during earthquakes, causing gas leaks.

If ignited, this can result in fires which can burn part of, or, the entire house.

About one in four fires after an earthquake is related to natural gas leaks.

Gas leaks after an earthquake are more likely if:

- There are structural weaknesses
- Gas appliances are not anchored
- Flexible pipe connections are not used.

The primary concern is property loss from fire damage.

The potential for life loss is limited since most single family homes have several safe exits.

How to Identify

- ✓ Examine all natural gas appliances (water heaters, dryers, stoves, ovens, furnaces) to see if they are anchored to the floor or walls, and have flexible pipe connections.

Plan Ahead

Locate your gas meter outside your home.

Identify the exact location of the shutoff valve and make sure that you have access to it.

Make sure you have a wrench that is readily available to turn off the gas when needed.

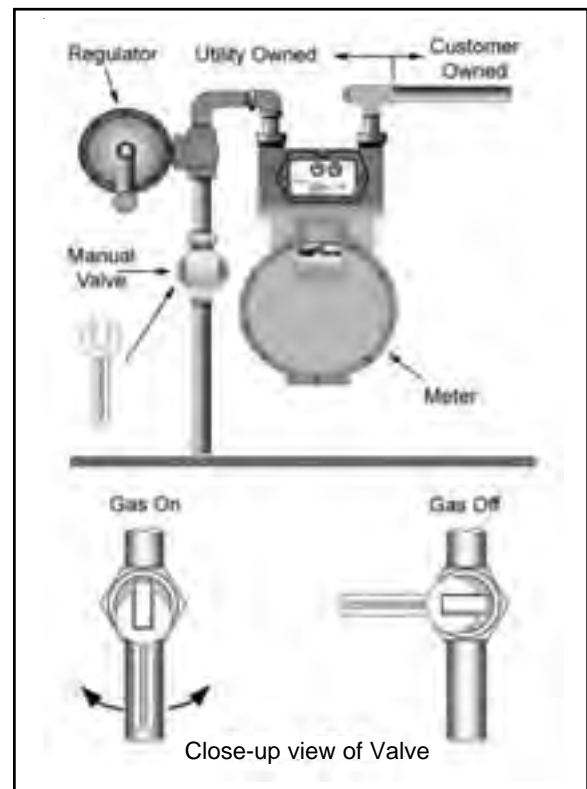

Figure 36—Manual Shutoff Valve Location

Manual Gas Shutoff

- The most cost-effective way to manage the risk from natural gas is to know how and when to manually shut off the gas.
- Use the wrench to turn off the manual valve located at the gas meter (*See Figure 36, page 32*).
- Shut off your gas only if you:
 - Smell gas
 - Hear gas escaping
 - Suspect a broken gas pipe, appliance, vent, or flue.

Remember

- Once the gas has been shutoff, service can be restored only by utility personnel or qualified plumbers.
- High demands for qualified personnel after an earthquake can lead to substantial delays in restoring natural gas service.

Resources

- [Seismic Gas Shut-Off Valve Requirements in Los Angeles](#), City of Los Angeles, Department of Building & Safety, Information Bulletin #P/PC 2002-001, April 30, 2003.
- [Improving Natural Gas Safety in Earthquakes](#), California Seismic Safety Commission, Publication #CSSC-02-03, July 2002.
- [Gas Shutoff Valve Certification Program](#), Division of the State Architect.

Automatic Gas Shutoff Options

There are a variety of automatic gas shut-off valves available. These cost more than manual shutoff valves and may provide additional safety but may also have some disadvantages.

The types of valves available include:

- Earthquake shake-actuated valves
- Excess flow valves
- Methane detectors
- Hybrid systems
- Others.

These can be installed on the “customer owned” side of the gas meter.

Consult your local Building Department because:

- Some installations will require building permits.
- Some local jurisdictions have adopted ordinances requiring automatic gas shutoff devices at the time of sale or during significant renovations.

GETTING THE WORK DONE

PLANS, PERMITS, AND CONTRACTORS

- Decide which strengthening project or projects you are going to do.
- Get the necessary building permits first.
 - If you are “doing-it-yourself,” you still need the proper permits.
 - For more complex projects, have a licensed architect or engineer draw up the necessary plans and specifications.
 - ✓ Interview two or three architects or engineers.
 - ✓ Ask for references or former clients.
 - ✓ Talk to references or former clients.
 - ✓ Compare experience, ideas, and fees.
 - Submit the plans for approval to your local building department.
 - Remember: the building codes are designed for your safety.
- Select your licensed contractor.
 - First make sure the contractor is properly licensed.
 - Interview at least two or three contractors.
 - Ask your licensed architect or engineer for recommendations.
 - Ask for references or former clients.
 - Talk to references or former clients.
 - Compare experience, fees, and terms of contract.
 - Get at least three written bids for the construction work.
 - The lowest bid may not be the best bid.
- Keep all plans, permits, and other records of your strengthening project.
 - Provide future buyers of your home with these.

There are many publications that describe strengthening projects in detail.

Visit the California Seismic Safety Commission’s website at www.seismic.ca.gov, which provides many useful links.

- Get the documents that relate to your project and read them.
 - This will help you to better understand what the architect or engineer is doing, and also what the contractor is doing.
- The International Existing Building Code Appendix Chapter 3 contains the best current guidelines. Ask your local Building Department to review a copy.

If your home has been designated as “historical,” you also may need to comply with the *California Historical Building Code*.

- Contact your local Building Department for further help with this.

REMEMBER

Whether you do it yourself, or hire a contractor, **you need permits** from your local Building Department.

It costs far less to correct earthquake weaknesses before an earthquake than to repair the damage after an earthquake.

If your home is damaged in an earthquake, you will probably also have other costs such as lodging, medical, etc.

DON'T HESITATE - MITIGATE!



AFTER A DISASTER – *HIRE A LICENSED CONTRACTOR!*

The contents of this section have been adapted from “After a Disaster, Don’t Get Scammed” by the Contractors State License Board.

After a Disaster...

DO NOT:

- Rush into repairs, no matter how badly they are needed.
- Hire the first contractor who comes along.
- Accept verbal promises.

DO:

- Get proof that the person you are dealing with is a California licensed contractor appropriate for the work to be done.
- Get the contractor’s license number and verify that it is current and valid.
- Get a written contract that contains all the details of the job to be performed.
- Get at least three bids.
- Check references of other work the contractor has done, if possible, in your area.
- Develop a payment schedule with the contractor.
- Consider a completion bond on large projects.

Contractors must be licensed for any job which costs \$500 or more, including materials and labor.

Avoid Payment Pitfalls

- By law, a down payment on a home improvement contract cannot exceed:
 - 10% of the contract price, or
 - \$1000whichever is less!
- Withhold at least 10% of the total contract price until the project is complete
- Do not make final payment until:
 - The building department has signed off on it,
 - You are satisfied with the job, and
 - You take a final walk-through to make sure work is complete and done correctly.

Useful publications from the Contractor’s State License Board (www.cslb.ca.gov):

- **What You Should Know Before You Hire a Contractor** - Provides information about hiring and working with contractors.
- **Home Improvement Contracts: Putting the Pieces Together** - Provides answers about the legal requirements of home improvement contractors.

GEOLOGIC HAZARDS

Sellers of real estate in California are required to disclose to buyers certain information regarding natural hazards that can affect the property being sold. In addition to flood and fire hazard information, disclosure of seismic hazards is also required.

Earthquakes are common in California because of the many earthquake faults located throughout the state.

This section:

- Describes briefly the basic geology-related hazards, and
- Introduces the government mapping programs that define which areas are susceptible to those hazards.

Ground Shaking:

- Ground shaking causes 99% of the earthquake damage to California homes.
- Areas near large active faults are more likely to be shaken severely than areas in the rest of the state.

Landslide:

- Earthquakes can also trigger landslides.
- Earthquake shaking can cause the soil and rock to slide off a slope, ripping apart homes on the slope and/or crushing homes downhill (See Figure 37).

Fault Rupture:

- An actual crack forms and the ground is offset along the two sides of a fault during an earthquake (See Figure 38).
- A house built over an active fault can be torn apart if the ground ruptures beneath it.
- If the house is built over a “creeping” fault – one that moves slowly with no earthquakes or a series of very small earthquakes – the damage may not be noticed for some time.



Patricia Grossi and Augustin Rodriguez, EERI

Figure 37 - Landslide. San Simeon Earthquake, December 22, 2003 Landslides on San Gregorio Road in Atascadero, California, only a short distance away from where the homes with the most damage were located.



Robert A. Eplert, OES, CA

Figure 38 - Fault Rupture. Landers Earthquake of June 28, 1992, produced a surface rupture of over 50 miles along faults in the Mojave Desert.

Lateral Spreading:

- Intense shaking during an earthquake can cause the soil to break into blocks which move apart from each other. This can cause damage to the foundation of a house (See *Figure 39*).

Liquefaction:

- During earthquakes, loose, wet sandy soil can become almost like quicksand, and lose its ability to support structures. This can cause the foundation of a house to sink, break, or tilt (See *Figure 40*).

Tsunami:

- A tsunami is a series of large sea waves caused by an underwater earthquake or landslide.
- Coastal areas are prone to tsunami damage.
- Tsunami waves can come from a great distance and can cause flooding or wash away houses in low-lying areas along the shore.

Dam Failure:

- Earthquake damage to a dam can cause sudden and devastating flooding of houses downstream.
- During the 1971 San Fernando Earthquake, the Lower San Fernando Dam above the San Fernando Valley was damaged. Had it failed, it would have flooded the homes below, causing many deaths and injuries. (See *Figure 41*). Risk of an aftershock forced residents in an 11-square mile area to evacuate for the next 3 days.
- California has some of the world's best standards for building and inspecting dams.

Recommendation:

If you live in a low-lying coastal area or a dam inundation zone, become familiar with evacuation routes to higher ground and be prepared to evacuate such areas immediately after an earthquake.



Figure 39 - Lateral Spreading. Loma Prieta Earthquake, October 17, 1989. Lateral spreading damage levee road along the San Lorenzo River.



Figure 40 - Loma Prieta Earthquake, October 17, 1989. Lateral spreading, liquefaction and sand boils caused extensive damage in the Marina District of San Francisco, about 60 miles away from the epicenter.



Figure 41 - Lower San Fernando Dam that was badly damaged by the 1971 San Fernando Earthquake.

Earthquake Hazard Mapping

Enormous progress has been made in understanding how, why, and where earthquakes occur. This has led to the creation of maps that highlight areas having the highest likelihood of damaging earthquakes.

Five mapping programs have been developed to help Californians lead safer lives in earthquake country.

National Seismic Zones

The U.S. is divided into four major zones, each having a different likelihood of strong ground shaking. The earthquake hazard potential for the U.S., determined through a national program, has been generalized into four seismic zones, numbered Zone 1 through Zone 4. Zone 1 has the lowest earthquake danger and Zone 4 has the highest earthquake danger. **Most of the densely populated parts of California are in Zone 4.** (See Figure 7, page 7)

The National Seismic Zone map is published by the International Code Council (ICC) in the California Building Code.

Earthquake Fault Zone Maps

These maps are also known as the *Alquist-Priolo Earthquake Fault Zone Maps*, named after the California legislators who initiated the legislation that mandated these maps. The maps show active earthquake faults prone to surface ruptures and identify a 1,000 ft. wide zone with the fault line at the center.

Seismic Hazard Zone Maps

These maps show areas where landslides and liquefaction are most likely to occur during earthquakes.

Tsunami Inundation and Evacuation Route Maps

Maps for the Pacific Coast show areas where low-lying regions are exposed to tsunami inundation. These maps are in various stages of preparation and availability.

Dam Inundation Maps

These maps show the areas below major dams that may be flooded in the event of their failure.

How are these Maps Used?

The zones defined by the maps are at greatest potential risk when a major earthquake occurs. This is particularly the case when the earthquake occurs during or shortly after a heavy rainfall, which increases the likelihood of liquefaction and landslides.

California law requires that the information from the Earthquake Fault Zone and Seismic Hazard Zone maps be incorporated into local general plans, and any land-use planning or permitting ordinances. Cities and counties must establish regulations governing development within these zones.

Special geotechnical studies are required before buildings can be built in Earthquake Fault Zones or Seismic Hazard Zones.

Your local building or planning department can show you the National Seismic Zone Map as well as the other maps if they are available for your community.

These maps, if they are available, may be accessed through www.seismic.ca.gov/hog.

The Seller of real estate within a hazard zone must disclose that the property lies within such a zone at the time of sale.

WHAT TO DO *DURING* AN EARTHQUAKE

DROP!



COVER!



HOLD ON!

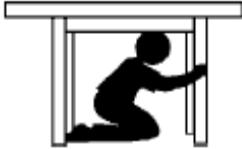

1. IF YOU ARE **INDOORS**—**STAY THERE!** “**DROP, COVER AND HOLD ON.**” Get under a sturdy desk or table and hang on to it, or move into a hallway or get against an inside wall. Stay clear of windows, fireplaces, and heavy furniture or appliances. Get out of the kitchen, which is a dangerous place in earthquakes since it’s full of things that can fall on you. Don’t run downstairs or rush outside while the building is shaking or while there is danger of falling and hurting yourself or being hit by falling glass or debris.
2. IF YOU ARE **OUTSIDE**—**GET INTO THE OPEN**, away from buildings, power lines, chimneys, and anything else that might fall on you.
3. IF YOU ARE **DRIVING**—**STOP**, but carefully. Move your car as far out of traffic as possible. Do not stop on or under a bridge or overpass or under trees, light posts, power lines, or signs. Stay inside your car until the shaking stops. When you resume driving, watch for breaks in the pavement, fallen rocks, and bumps in the road.
4. IF YOU ARE ON OR NEAR A **STEEP HILLSIDE**—**WATCH OUT FOR LANDSLIDES**, falling rock, trees, and other debris that could be loosened by earthquakes.

If You Feel a Strong Earthquake or Receive a Tsunami Warning When You are on the Coast

1. **DROP, COVER AND HOLD ON.** Watch for falling objects until the earthquake is over.
2. **MOVE TO HIGHER GROUND** or inland away from the coast immediately. A tsunami may be coming. Go on foot if possible. The first waves may reach the coast within minutes after the ground shaking stops. The first wave is almost never the largest. Later waves may be spaced tens of minutes apart and can continue arriving for many hours.
3. **THERE MAY BE NO TIME FOR AUTHORITIES TO ISSUE A WARNING.** If you do not hear an evacuation announcement but notice a sudden drop or rise in water level or hear a loud noise coming from the water, nature may be warning you of impending danger.
4. **STAY AWAY FROM THE COAST.** Do not return to the shore after the first wave. Waves may continue to arrive for hours.
5. **LISTEN TO A RADIO FOR AN “ALL CLEAR”** before returning to the shore.

WHAT TO DO *BEFORE* AN EARTHQUAKE

The information contained in this section does not represent weaknesses in the earthquake resistance of homes. It is valuable information to keep in mind to reduce risks to yourself, your family, and your home. These lists are only highlights of the actions you should take.

Gather Emergency Supplies

Be sure you have these basic supplies on hand:

- Fire extinguisher
- Adequate supplies of medications that you or family members are taking
- Crescent and pipe wrenches to turn off gas and water supplies
- First-aid kit and handbook
- Flashlights with extra bulbs and fresh batteries
- Portable battery-powered radio or television and extra fresh batteries
- Water for each family member for at least three days (allow at least one gallon per person per day) and purification tablets or chlorine bleach to purify drinking water from other sources
- Canned and packaged foods, enough for three days, and at least an additional four-day supply readily accessible for use if you are confined to home. Don't forget a mechanical can opener and extra pet food!
- Camp stove or barbecue to cook on outdoors (store fuel out of the reach of children)
- Waterproof, heavy-duty plastic bags for waste disposal
- Copies of personal identification, such as driver's licenses, passports, and work identification badges, and copies of medical prescriptions and credit cards
- An extra set of car keys and house keys
- Matches in waterproof container
- Map of the area marked with places you could go and their telephone numbers
- Cash and coins
- Special items, such as denture needs, contact lenses and supplies, extra eyeglasses, and hearing aid batteries
- Items for seniors, disabled persons, or anyone with serious allergies
- Items for infants, such as formula, diapers, bottles, pacifiers, powdered milk, and medications not requiring refrigeration

Plan Ahead



1. Create a family disaster plan; practice and maintain the plan.
2. Make and complete a checklist.
3. Plan home escape routes.
4. Conduct fire and emergency evacuation drills at least twice a year and include your pets in your evacuation and sheltering drills.
5. Test your smoke alarms once a month (daylight savings time or birthdays) and replace batteries at least once a year in battery-powered smoke alarms.
6. Make sure each member of your family knows what to do no matter where they are when earthquakes occur.
 - Establish two meeting places where you can all reunite afterward: one right outside your home, in case of a sudden emergency, and one outside your neighborhood in case you cannot return home or are asked to leave your neighborhood.
 - Find out about the earthquake plan developed by your children's school or day care.
 - Remember that since transportation may be disrupted, you may have to stay at your workplace for a day or two following a major earthquake. Keep some emergency supplies—food, liquids, and comfortable shoes, for example—at work.
 - Pick two out-of-town contacts:
 - A friend or relative who will be your household's **primary** contact,
 - A friend or relative who will be your household's **alternative** contact.
7. Know where your gas, electric, and water main shutoffs are and how to turn them off if there is a leak or electrical short; if in doubt, ask your utility companies. Make sure that all the older members of your family can shut off the utilities.
8. Locate your nearest fire and police stations and emergency medical facility. Remember that telephones may not work after an earthquake. If you can, use your land line rather than your cell phone to call 911, but only if you need emergency help.
9. Talk to your neighbors—how could they help you, or you help them, after an earthquake?
10. Take a Red Cross first aid and cardiopulmonary resuscitation (CPR) training course.
11. Make arrangements with friends or relatives to temporarily house **your pets** after disasters because emergency shelters will not accept pets.
12. If your home is located near a steep hillside, in an area near the shore of a body of water or below a dam, check with your local building or planning department to see if you are in a landslide, tsunami or dam inundation zone. Plan for how, when, and where your family should evacuate.

WHAT TO DO *AFTER* AN EARTHQUAKE

*Wear sturdy shoes to avoid injury from broken glass and debris.
Expect aftershocks.*

Check for Injuries

1. If a person is bleeding, put direct pressure on the wound. Use clean gauze or cloth, if available.
2. If a person is not breathing, administer rescue breathing. The front pages of many telephone books contain instructions on how to do it along with detailed instructions on other first-aid measures.
3. Do not attempt to move seriously injured persons unless they are in immediate danger of further injury.
4. Cover injured persons with blankets to keep them warm.
5. Seek medical help for serious injuries.

Check for Hazards

1. *Fire or fire hazards.* Put out fires in your home or neighborhood immediately. Call for help, but don't wait for the fire department.
2. *Gas leaks.* Shut off the main gas valve only if you suspect a leak because of broken pipes or the odor of natural gas. Don't turn it back on yourself—wait for the gas company to check for leaks.
3. *Damaged electrical wiring.* Shut off power at the control box if there is any damage to your house wiring.
4. *Downed or damaged utility lines.* Do not touch downed power lines or any objects in contact with them.
5. *Spills.* Clean up any spilled medicines, drugs, or other potentially harmful materials such as bleach, lye, and gasoline or other hazardous materials.
6. *Downed or damaged chimneys.* Approach chimneys with caution. They may be weakened and could topple during aftershocks. Don't use a fireplace with a damaged chimney—it could start a fire or let poisonous gases into your house.
7. *Fallen items.* Beware of items tumbling off shelves when you open the doors of closets and cupboards.

Check Your Food and Water Supplies

1. If power is off, plan meals to use up foods that will spoil quickly, or frozen foods. If you keep the door closed, food in your freezer should be good for at least a couple of days.
2. Don't light your kitchen stove if you suspect a gas leak.
3. Use barbecues or camp stoves, outdoors only, for emergency cooking.
4. If your water is off, you can drink supplies from water heaters, melted ice cubes, or canned vegetables. Try to avoid drinking water from swimming pools or, especially, spas—it may have too many chemicals in it to be safe.

Note: The information in these sections is reproduced in whole or in part with the permission of the copyright owner, SBC. The Survival Guide is available in the White Pages of SBC Directories © SBC 2004. This information was provided by medical and emergency service authorities and published as a public service. While every reasonable effort was made to ensure its accuracy, SBC is not responsible and assumes no liability for any action undertaken by any person in utilizing such information. Any person relying upon such information does so at his or her own risk.

Do Not . . .

- **Do not** eat or drink anything from open containers near shattered glass.
- **Do not** turn the gas on again if you turned it off; let the gas company do it.
- **Do not** use matches, lighters, camp stoves or barbecues, electrical equipment—including telephones—or appliances until you are sure there are no gas leaks. They may create sparks that could ignite leaking gas and cause an explosion and fire.
- **Do not** use your telephone, except for a medical or fire emergency. You could tie up lines needed for emergency response.
If you need help and the phone doesn't work, send someone for help.
- **Do not** expect firefighters, police, or paramedics to help you right away. They may not be available.

RESOURCE ORGANIZATIONS

Some of the organizations listed below have information to help you strengthen your home against earthquakes and help you and your family prepare a personal earthquake response plan. Other resources that can help you may be available in your community; check your local telephone directory.

Home Safety Information

Office of Emergency Services

Main Office

Information and Public Affairs
P.O. Box 419047
Rancho Cordova, CA 95741-9047
Telephone: (916) 845-8400
<http://www.oes.ca.gov>

Regional Offices:

Coastal Region

1300 Clay Street, Suite 408
Oakland, CA 94612
Telephone: (510) 286-0895

Inland Region

P.O. Box 419047
Rancho Cordova, CA 95741-9047
Telephone: (916) 845-8470

Inland Region South

2550 Mariposa Mall, Room 181
Fresno, CA 93721
Telephone: (559) 445-5672

Southern Region

4671 Liberty Avenue
Los Alamitos, CA 90720
Telephone: (562) 795-2900

California Seismic Safety Commission

1755 Creekside Oaks Drive, Ste. 100
Sacramento, CA 95833
Telephone: (916) 263-5506
www.seismic.ca.gov

California Earthquake Authority

801 K Street, Suite 1000
Sacramento, CA 95814
Telephone: (877) 797-4300
<http://www.earthquakeauthority.com>

Structural Safety Information

American Institute of Architects

Local chapters have referral lists of licensed architects; consult telephone directory listing for "American Institute of Architects."
<http://www.aia.org>

Structural Engineers Association of California

1730 I Street, Suite 240,
Sacramento, CA 95814-3017
Telephone: (916) 447-1198
<http://www.seaoc.org>

Local chapter organizations have referral list for licensed structural engineers as follows:

San Diego - <http://www.seaosd.org>
Southern California - <http://www.seaosc.org>
Northern California - <http://www.seaonc.org>
Central California - <http://www.seaocc.org>

American Society of Home Inspectors

932 Lee Street, Suite 101
Des Plaines, IL 60016
Telephone: (800) 743-2744
<http://www.ashi.com>
Referral list of licensed inspectors.

Building Education Center

812 Page Street
Berkeley, CA 94710
Telephone: (510) 525-7610
<http://www.bldgeductr.org>

California Real Estate Inspection Association

1445 N. Sunrise Way, Suite 101
Palm Springs, CA 92262
Telephone: (800) 848-7342 (information)
<http://www.creia.org/>

Call for pamphlet describing house inspection services offered by members and referrals to qualified members.

Consulting Engineers and Land Surveyors of California

1303 J Street, Suite 450
Sacramento, CA 95814
Telephone: (916) 441-7991
<http://www.celsoc.org/>
A referral list for licensed engineers is available.

International Code Council

5360 Workman Mill Road
Whittier, CA 90601-2298
Telephone: (800) 284-4406
<http://www.iccsafe.org>

Geologic Information

Association of Bay Area Governments

P.O. Box 2050
Oakland, CA 94604
Telephone: (510) 464-7900
<http://www.abag.ca.gov>
A consortium of local governments in the San Francisco Bay Area, offering a variety of information, including lists of local resources.

California Geological Survey

California Department of Conservation
801 K Street, MS 12-30
Sacramento, CA 95814
Telephone: (916) 445-1825
<http://www.consrv.ca.gov/cgs>
The CGS is the state agency responsible for geological research, mapping, and policy. It provides maps and other information to the general public.

Southern California Earthquake Center

University of Southern California
3651 Toursdale Parkway, Suite 169
Los Angeles, CA 90089-0742
Telephone: (213) 740-5843
<http://www.scec.org>

United States Geological Survey

Earth Science Information Center
345 Middlefield Road
Menlo Park, CA 94025
Telephone: (650) 853-8300
<http://www.usgs.gov>
This is the federal agency responsible for geological and earthquake hazard research, mapping, and policy. It provides maps and other information to the general public.

Cities and Counties

Consult your telephone directory under city or county government listings for the office of emergency services or disaster management, city or county building and planning department, and city or county government geologist.

Emergency Planning Information

Federal Emergency Management Agency

Region IX
1111 Broadway, Suite 1200
Oakland, CA 94607
Telephone: (510) 627-7100
<http://www.fema.gov>
FEMA offers a publications lists and referrals to preparedness organizations. FEMA also provides information on Federal Disaster Aid Programs that become available after Federal disasters.

American Red Cross

Consult your telephone directory for the address and phone number of your local chapter.
<http://www.redcross.org>



HOW TO FILL OUT THE DISCLOSURE FORM

When you sell a home that was built before 1960, you are required to fill out the form shown on the next page.

- Sellers must hand buyers a **completed** disclosure report.
- Sellers must answer the questions to the best of their knowledge.
- If a question on the form describes only part of your house—for example if part of your house is anchored to the foundation and the other part is not—sellers should answer the question with a “NO” because a portion of the house is not properly anchored.
- Sellers are not required to remove siding, drywall, or plaster in order to answer the questions.
- Sellers are not required to hire anyone to inspect their homes.
- Sellers are not required to fix the weaknesses before they sell their homes.

Residential Earthquake Hazards Report (2005 Edition)

NAME	ASSESSOR'S PARCEL NO.
STREET ADDRESS	YEAR BUILT
CITY AND COUNTY	ZIP CODE

Answer these questions to the best of your knowledge. If you do not have actual knowledge as to whether the weakness exists, answer "Don't Know." If your house does not have the feature, answer "Doesn't Apply." The page numbers in the right-hand column indicate where in this guide you can find information on each of these features.

	Yes	No	Doesn't Apply	Don't Know	See Page
1. Is the water heater braced, strapped, or anchored to resist falling during an earthquake?	<input type="checkbox"/>	<input type="checkbox"/>	<input type="checkbox"/>	<input type="checkbox"/>	12
2. Is the house anchored or bolted to the foundation?	<input type="checkbox"/>	<input type="checkbox"/>	<input type="checkbox"/>	<input type="checkbox"/>	14
3. If the house has cripple walls:					
• Are the exterior cripple walls braced?	<input type="checkbox"/>	<input type="checkbox"/>	<input type="checkbox"/>	<input type="checkbox"/>	16
• If the exterior foundation consists of unconnected concrete piers and posts, have they been strengthened?	<input type="checkbox"/>	<input type="checkbox"/>	<input type="checkbox"/>	<input type="checkbox"/>	18
4. If the exterior foundation, or part of it, is made of unreinforced masonry, has it been strengthened?	<input type="checkbox"/>	<input type="checkbox"/>	<input type="checkbox"/>	<input type="checkbox"/>	20
5. If the house is built on a hillside:					
• Are the exterior tall foundation walls braced?	<input type="checkbox"/>	<input type="checkbox"/>	<input type="checkbox"/>	<input type="checkbox"/>	22
• Were the tall posts or columns either built to resist earthquakes or have they been strengthened?	<input type="checkbox"/>	<input type="checkbox"/>	<input type="checkbox"/>	<input type="checkbox"/>	22
6. If the exterior walls of the house, or part of them, are made of unreinforced masonry, have they been strengthened?	<input type="checkbox"/>	<input type="checkbox"/>	<input type="checkbox"/>	<input type="checkbox"/>	24
7. If the house has a living area over the garage, was the wall around the garage door opening either built to resist earthquakes or has it been strengthened?	<input type="checkbox"/>	<input type="checkbox"/>	<input type="checkbox"/>	<input type="checkbox"/>	26
8. Is the house outside an Alquist-Priolo Earthquake Fault Zone (zones immediately surrounding known earthquake faults)?					36
9. Is the house outside a Seismic Hazard Zone (zone identified as susceptible to liquefaction or landsliding)?					36

*To be reported on the
Natural Hazards Disclosure
Report*

Keep your copy of this form for future reference

If any of the questions are answered "No," the house is likely to have an earthquake weakness. Questions answered "Don't Know" may indicate a need for further evaluation. If you corrected one or more of these weaknesses, describe the work on a separate page.

As seller of the property described herein, I have answered the questions above to the best of my knowledge in an effort to disclose fully any potential earthquake weaknesses it may have.

EXECUTED BY

(Seller)

(Seller)

Date

I acknowledge receipt of this form, completed and signed by the seller. I understand that if the seller has answered "No" to one or more questions, or if seller has indicated a lack of knowledge, there may be one or more earthquake weaknesses in this house.

(Buyer)

(Buyer)

Date

This earthquake disclosure is made in addition to the standard real estate transfer disclosure statement also required by law.

**CLAIM FOR SEISMIC SAFETY CONSTRUCTION
EXCLUSION FROM ASSESSMENT**

(Section 74.5 of the Revenue and Taxation Code)

This form must be filed with the Assessor prior to, or within 30 days of, completion of construction.

FOR ASSESSOR'S USE ONLY	
<input type="checkbox"/> Received	_____
<input type="checkbox"/> Approved	_____
<input type="checkbox"/> Denied	_____
Reason for denial	_____

SAMPLE FORM
for Santa Clara County

PROPERTY DESCRIPTION	
Parcel No.(s)	_____
Address	_____

STATEMENTS

1. As the owner of the property described above, I completed, or will complete, construction on this property on _____, and therefore claim the construction exclusion from assessment provided by section 74.5 of the California Revenue and Taxation Code.
2. I understand this exclusion from assessment is applicable only to seismic retrofitting improvements and improvements utilizing earthquake hazard mitigation technologies, to an existing building or structure and is not applicable to alterations, such as new plumbing, electrical, or other added finishing materials, made in addition to seismic-related work performed on an existing structure.
3. I further understand this exclusion from assessment does not encompass the exclusion provided by Revenue and Taxation Code section 70(d) pertaining to the portion of reconstruction or improvement to a structure, constructed of unreinforced masonry bearing wall construction, necessary to comply with any local ordinance relating to seismic safety during the first 15 years following that reconstruction or improvement.
4. The property owner, primary contractor, civil engineer, or architect has has not certified to the building department those portions of the project that are seismic retrofitting improvements or improvements utilizing earthquake hazard mitigation technologies.

THIS EXCLUSION EXPIRES UPON CHANGE IN OWNERSHIP OF THE PROPERTY

CERTIFICATION

I certify (or declare) under penalty of perjury under the laws of the State of California that the foregoing and all information hereon, including any accompanying statements or documents, is true, correct, and complete to the best of my knowledge and belief.

SIGNATURE



DATE

DAYTIME PHONE NO.

()

Only the owner or a co-owner of the above-described property (including a purchaser under contract of sale) or his or her legal representative may sign.

If you are buying this property under an unrecorded contract of sale and the Assessor does not have a copy of the contract, you must attach a copy to the claim.

SUPPORTING DOCUMENTS MUST BE FILED WITHIN SIX MONTHS OF COMPLETION OF THE PROJECT.

I found the booklet, *The Homeowner's Guide to Environmental Hazards and Earthquake Safety (with gas shut-off valve update)* which includes the *Federal Lead booklet and Toxic Mold Update*:

- Helpful
- Too detailed
- Not detailed enough
- Clearly written
- Confusing
- The booklet helped me to locate earthquake weaknesses in my home.
- I have strengthened my home to resist earthquakes.
- I plan to fix my home's earthquake weaknesses.
- The booklet helped me find out that my home did not have any earthquake weaknesses.

The year my home was built was _____.

Comments: _____

We Want To Hear From You!

California Seismic Safety Commission
1900 K Street, Suite 100
Sacramento, California 95814-4186

To Whom It May Concern: I have received a copy of the Environmental Hazards and Earthquake Safety (with gas shut-off valve update) which includes the Federal Lead booklet and Toxic Mold Update, and Home Energy Rating booklet.

Property Address: _____

Date _____ Time _____
(Buyer's signature) (printed name)

Date _____ Time _____
(Buyer's signature) (printed name)

Date _____
(Buyer's Agent's signature) (printed name) (Broker's name)

NOTE: For applicable transactions, it is also necessary to complete C.A.R. Standard form FLD-11 (Lead-based paint and Lead-based paint Hazards Addendum, Disclosure and Acknowledgement.)

ALL SIGNERS SHOULD RETAIN A COPY OF THIS PAGE FOR THEIR RECORDS

California Civil Code Section 2079.10 states that if the HERS booklet is provided to the Buyer by the Seller or Broker, then this booklet is deemed to be adequate to inform the home buyer about the existence of California Home Energy Rating Program.

Revised 09/10 Official C.A.R. * Publication 09/10

To Whom It May Concern: I have received a copy of the Environmental Hazards and Earthquake Safety (with gas shut-off valve update) which includes the Federal Lead booklet and Toxic Mold Update, and Home Energy Rating booklet.

Property Address: _____

Date _____ Time _____
(Seller's signature) (printed name)

Date _____ Time _____
(Seller's signature) (printed name)

Date _____
(Listing Agent's signature) (printed name) (Broker's name)

NOTE: For applicable transactions, it is also necessary to complete C.A.R. Standard form FLD-11 (Lead-based paint and Lead-based paint Hazards Addendum, Disclosure and Acknowledgement.)

ALL SIGNERS SHOULD RETAIN A COPY OF THIS PAGE FOR THEIR RECORDS

California Civil Code Section 2079.10 states that if the HERS booklet is provided to the Buyer by the Seller or Broker, then this booklet is deemed to be adequate to inform the home buyer about the existence of California Home Energy Rating Program.

Revised 09/10 Official C.A.R. * Publication 09/10



 **FIDELITY
NATIONAL
HOME WARRANTY**

Tel: 1-800-TOCOVER (800-862-6837)

Fax: 1-800-308-1460

www.homewarranty.com

 **DISCLOSURE
SOURCE**

Tel: 1-800-880-9123

Fax: 1-800-287-8673

www.disclosuresource.com