



FOOD WASTE DISPOSERS

GUIDE FOR EASY, TROUBLE-FREE INSTALLATION, CARE AND USE.

HOW THIS GUIDE WILL HELP YOU.

This guide describes everything you need to know to install your new food waste disposer, including care and use information. If you take your time, follow the instructions and drawings, you should

have no trouble making a first-rate installation.

NOTE: Read through the entire guide before you start installation so you can get all the tools and materials you will need with one trip to the store.

These are the tools and materials you will need.

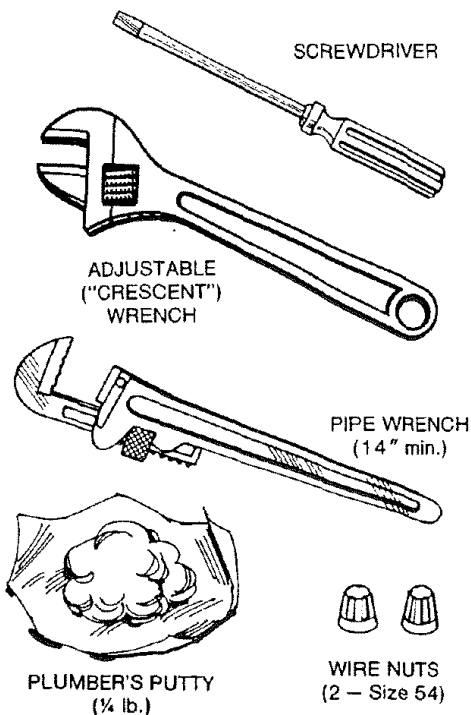

These are the tools and materials you may need.

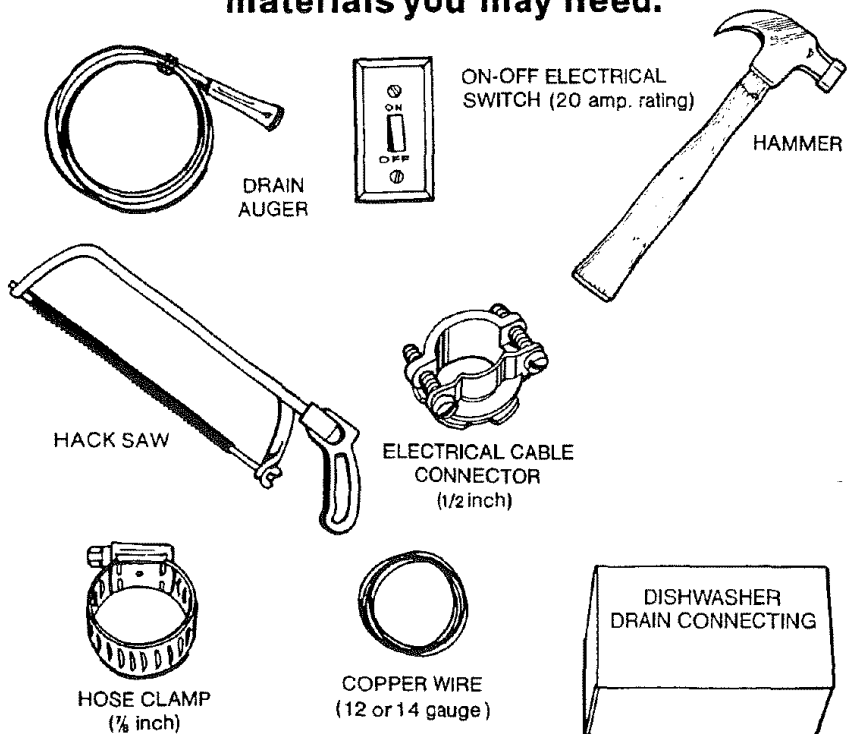

WP71865

INSTALLATION DIMENSIONS

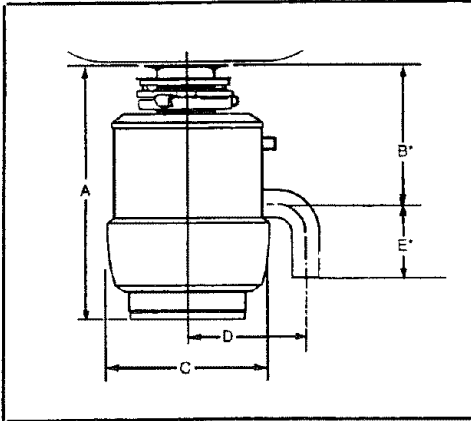

DRAWING REPRESENTATIVE OF
A FOOD WASTE DISPOSER

IMPORTANT: PLUMB WASTE LINE TO PREVENT STAND-
ING WATER IN DISPOSER MOTOR HOUSING.

DISPOSER NO.	A	B*	C	D	E*
175.6010	11 ³ / ₈ "	6"	6 ³ / ₈ "	5"	4"
175.6012	11 ³ / ₈ "	6"	6 ³ / ₈ "	5"	4"
175.6011	12 ⁵ / ₈ "	6"	6 ³ / ₈ "	5"	4"
175.6013	12 ⁵ / ₈ "	6"	6 ³ / ₈ "	5"	4"
175.6035	12 ³ / ₄ "	6 ³ / ₄ "	7 ¹ / ₄ "	5"	4"
175.6040	12 ³ / ₄ "	6 ⁷ / ₈ "	7 ³ / ₄ "	5 ³ / ₄ "	4"
175.6058	13 ¹ / ₈ "	6 ⁷ / ₈ "	7 ³ / ₄ "	5 ³ / ₄ "	4"
175.60514	12 ¹³ / ₁₆ "	6 ³ / ₄ "	8 ¹ / ₂ "	5 ³ / ₄ "	4"
175.6109	13 ³ / ₄ "	6 ⁷ / ₈ "	8 ⁵ / ₈ "	5 ³ / ₄ "	4"
175.60525	15 ¹ / ₂ "	9 ¹ / ₂ "	7 ¹ / ₂ "	5"	4"
175.60509	12 ³ / ₄ "	6 ³ / ₄ "	7 ¹ / ₄ "	5"	4"
175.60542	12 ³ / ₄ "	6 ⁷ / ₈ "	7 ³ / ₄ "	5 ³ / ₄ "	4"

NOTE: Please refer to the dimensions which match your disposer model number.

B* - DISTANCE FROM BOTTOM OF SINK TO CENTER LINE OF DISPOSER OUTLET. ADD 1/2" WHEN STAINLESS STEEL SINKS ARE USED.

E* - LENGTH OF DISCHARGE TUBE FROM CENTER LINE OF DISPOSER OUTLET TO END OF DISCHARGE TUBE.

OKAY, LET'S START THE INSTALLATION ONE STEP AT A TIME.

1 CHECK THE PARTS AGAINST THE DRAWINGS BELOW AND MAKE SURE EVERYTHING IS THERE. (Your new disposer may not look like the one pictured.)

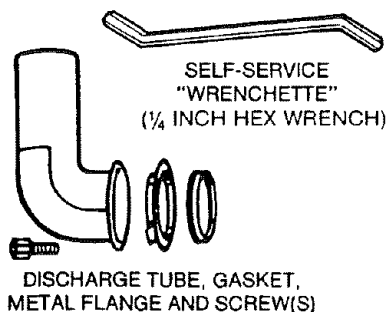

THE MOUNTING ASSEMBLY
CONSISTING OF:

Sink sleeve



Fiber gasket



Back-up ring



Mounting ring
and 3 screws



Snap ring

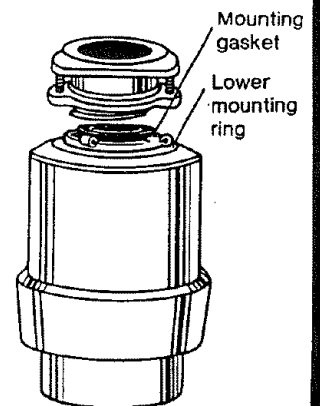

2

REMOVING YOUR OLD DISPOSER.

FIRST, TURN OFF ELECTRICAL POWER at the service panel (fuse box or circuit breaker box). If the mounting is the same as your new disposer's mounting, you can use the existing mounting. Follow instructions A through E, Step 2, then go on to Step 10.

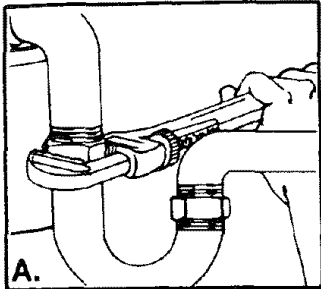

A. Use a pipe wrench to disconnect the drain line where it attaches to the disposer discharge tube.

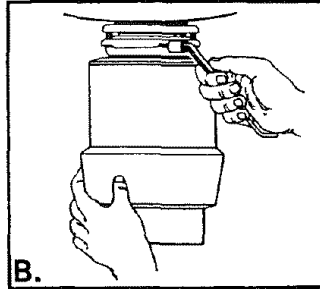

B. IF YOUR OLD DISPOSER HAS A DIFFERENT MOUNTING THAN YOUR NEW ONE, GO ON TO INSTRUCTION C.

If your old disposer has the same mounting as your new one, insert the end of your "wrenchette" or screwdriver into the right side of one of the disposer mounting ring lugs at the top of the disposer. Then, turn the "wrenchette" or screwdriver to the left (counterclockwise) until the lug lines up with one of the sink mounting assembly screws.

CAUTION: Be sure to hold the disposer with one hand while performing this step or it may fall when the mounting ring is disconnected from the sink mounting assembly. GO TO INSTRUCTION D.

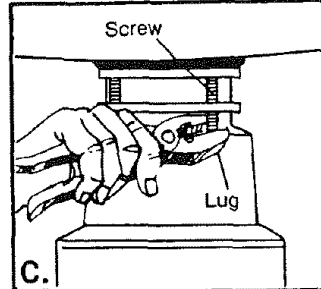

C. If your old disposer has a different mounting than your new one, use a pliers or adjustable wrench to remove the nuts on the mounting ring. Then remove old disposer. (Some disposers have to be removed by taking off a clamp or by twisting the disposer to remove it from its mounting. Easy to figure out.)

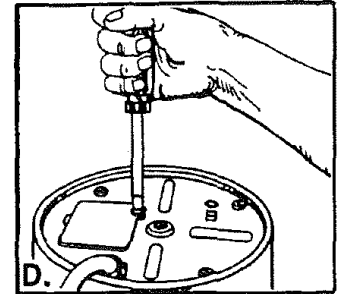

D. Once the disposer is off, turn it upside down and remove the electrical plate.

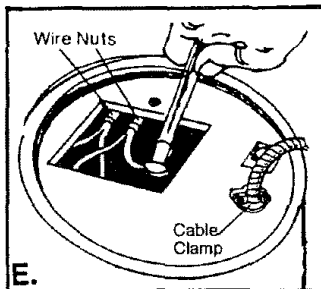

E. Now, use a screwdriver to remove ground wire. Remove the wire nuts from the power wires. Separate the disposer power wires from the cable wires. Loosen the screw(s) on the cable clamp and remove the cable from the disposer.

If your old disposer has a different mounting than your new one, follow steps F and G. Otherwise go on to Step 3.

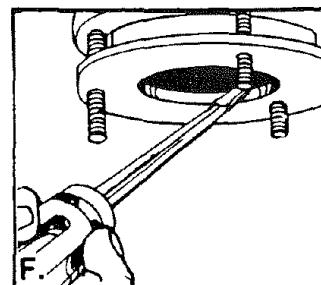

F. Loosen screws and remove old mounting ring and back-up ring. You may need a hammer to loosen assembly parts.

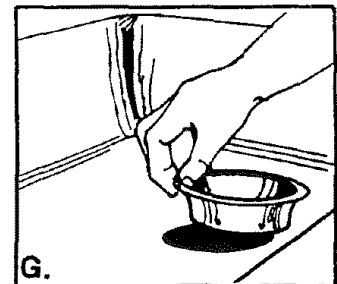

G. Finally, remove the old sink sleeve by pushing it up through the sink hole.

3

CLEANING YOUR SINK'S DRAIN LINE.

NOTE: In case of new construction, you may skip this step.

The cutting elements on your old disposer were probably worn and not grinding the waste completely. Your drain line may be partially blocked. We recommend cleaning the line before connecting your new Kenmore disposer.

You can do the job yourself with a drain auger. Remove the drain trap and, using the auger, clean out the horizontal drain pipe that runs from the trap to the main waste pipe.

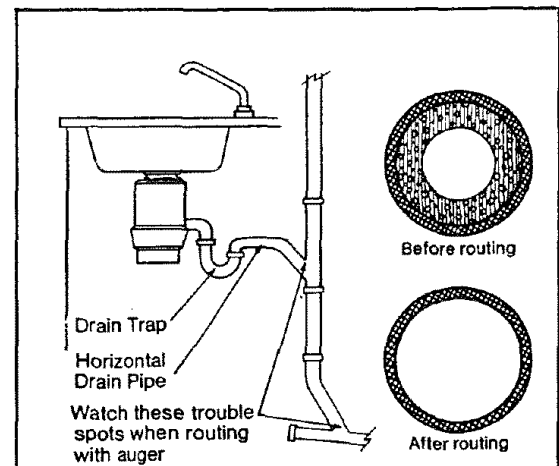

4

HERE IS WHAT TO DO IF YOU ARE INSTALLING YOUR SINK'S FIRST DISPOSER.

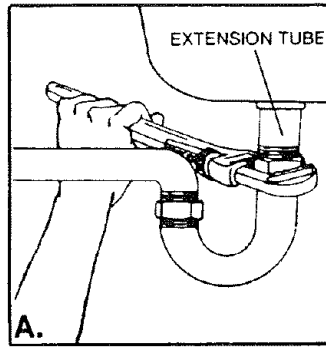

A. Use a pipe wrench to loosen the nut at the top of the drain trap.

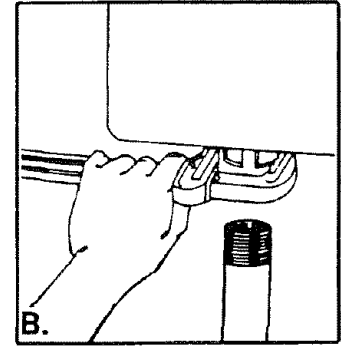

B. Next, remove the nut at the top of the sink strainer and remove the extension tube.

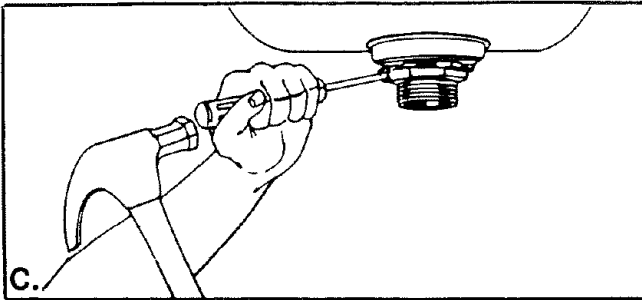

C. Now, remove the large nut at the base of the sink strainer by placing the tip of your screwdriver on the edge of the nut. (There are usually ridges to hold your screwdriver.) Then strike the head of the screwdriver with a hammer in a counterclockwise direction.

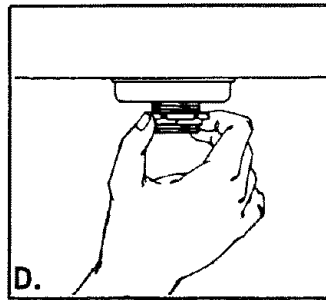

D. Loosen the nut until you can spin it off by hand.

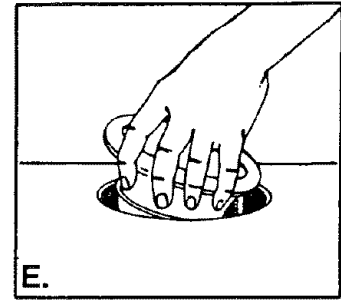

E. Now, push the strainer up through the sink hole and remove it.

5

ELECTRICAL SUPPLY.

Before you begin this job, you should be thoroughly familiar with electrical power and proper procedures. Local electrical codes must be followed. If you are not sure, call in a professional who is knowledgeable.

This appliance is equipped with copper wires. Use 3 conductor copper cable in accordance with your local code to make your connections to the unit.

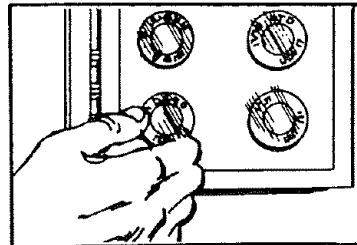

First, remove the fuse or turn off the circuit breaker on the circuit you plan to use for your disposer. Use a separate 15 or 20 amp., 115 volt circuit for the disposer.

If you are replacing an old disposer, skip to Step 6.

Except for batch feed models, this disposer requires that a wall switch with a marked off position and wired to disconnect all ungrounded supply conductors be installed within sight of the disposer sink opening.

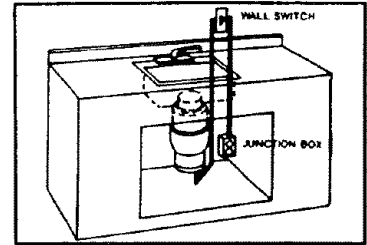

It will be necessary to install a 20 amp. wall switch above the countertop and a junction box under the sink as illustrated.

Position the switch in any convenient location, and connect to junction box. All wiring must comply with local electrical codes.

14 gauge size wire is the smallest permissible for use with a 15 amp. circuit, and 12 gauge size wire is the smallest permissible for use with a 20 amp. circuit.

6

CLEAN THE OLD SEALANT FROM THE RIM OF THE SINK HOLE.

Use your screwdriver or a putty knife to scrape away all traces of the old putty or caulking from the edge of the sink drain hole. Make sure you get this as clean as possible so that you'll have a good, water-tight seal for your new disposer sink sleeve.

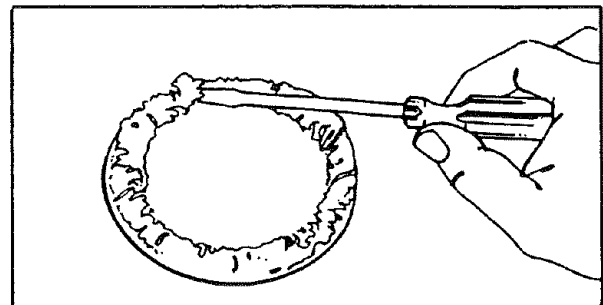

LET'S KEEP GOING...IT'S GETTING EASIER, WE HOPE.

7 NOW WE'RE GETTING INTO THE ACTUAL INSTALLATION. SEPARATE THE PARTS IN THE MOUNTING ASSEMBLY.

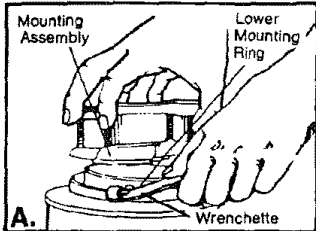

First, remove the mounting assembly from the lower mounting ring. Holding the mounting assembly with one hand, insert your wrenchette or screwdriver into one of the lugs of the lower mounting ring and turn it to the left (counterclockwise) with your other hand.

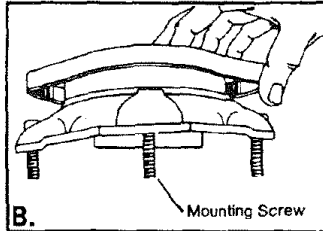

Then loosen the screws on the mounting assembly until they are just level with the surface of the mounting ring.

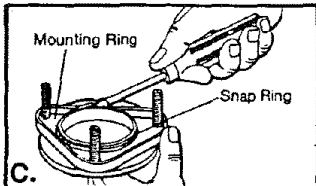

Now, use a screwdriver to pry off the snap ring.

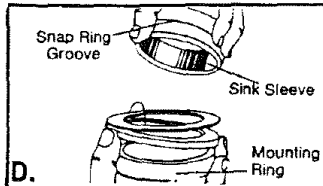

The assembly will now come apart. Set it aside and move to the next step.

8 APPLY PUTTY TO THE SINK SLEEVE.

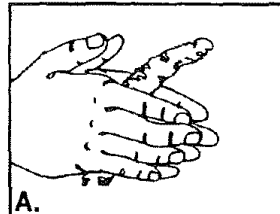

Make a fat snake of "plumber's" putty by rolling it between your hands.

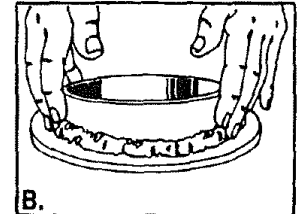

Apply this roll under the rim of the sink sleeve.

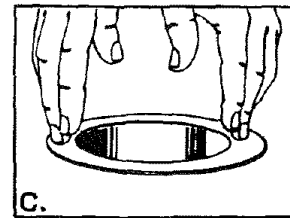

Then, place the sink sleeve into the sink drain hole and push down gently but firmly to make sure it sits evenly in the putty.

9 NEXT, LET'S ATTACH THE UPPER MOUNTING ASSEMBLY.

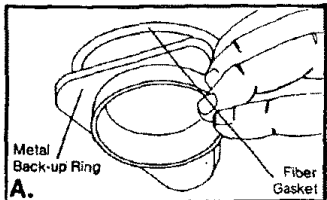

First, working from under the sink, slip the fiber gasket and next the metal back-up ring (flat side up) up and over the sink sleeve.

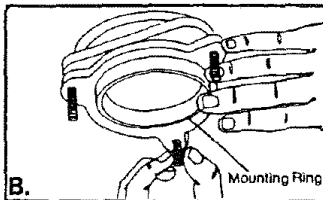

Hold the fiber gasket and metal back-up ring in place with one hand and place the mounting ring with its three screws onto the sink sleeve.

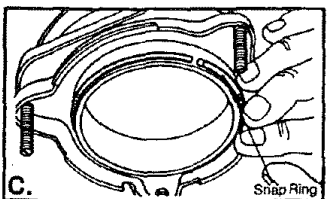

Now, push the fiber gasket, metal back-up ring and the mounting ring further up on the sink sleeve. Slide the snap ring onto the sink sleeve until it pops into place in the groove on the sleeve.

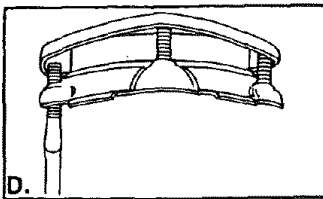

Tighten the three mounting screws with your screwdriver until the whole mounting assembly is seated evenly and tightly against the sink.

10 TURN YOUR NEW DISPOSER UPSIDE DOWN AND REMOVE THE ELECTRICAL PLATE FROM THE DISPOSER SO YOU CAN SEE THE WIRING AND THE GROUND SCREW. THE BOTTOM OF YOUR DISPOSER WILL LOOK LIKE THE ONES SHOWN IN 'A' OR 'B'.

(Start here if you are replacing a disposer with the same mounting.)

Remove the electrical plate from the bottom of the disposer and pull out the black and white electrical wires. The green ground screw is also under this plate.

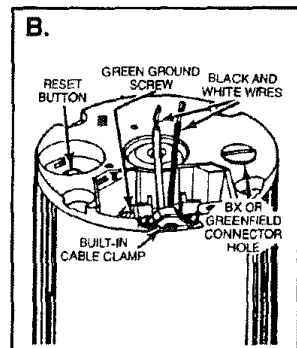
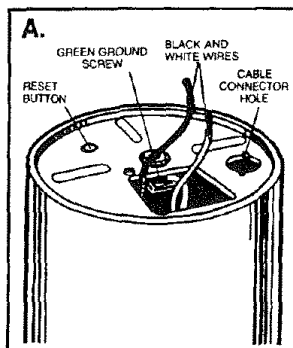

11

WE'RE READY TO MAKE THE ELECTRICAL CONNECTIONS.

NOTE: If using armored cable, we recommend installing an anti-short or insulation bushing in the end of the cable.

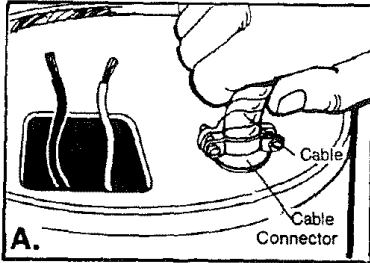

Do not fold or remove the brown electrical insulation paper from inside the wiring compartment.

Install the cable connector. Then loosen the connector screw(s). (Some disposers have a connector built in, on others you will have to install one which must meet local electrical codes).

Work the cable from the on-off switch through the connector so that the leads are in the electrical wiring area in the disposer base.

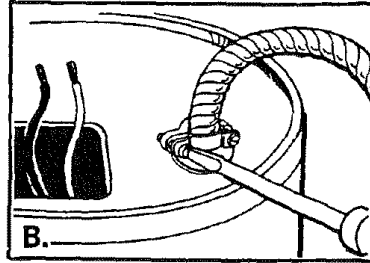

Now, tighten the connector clamp screw(s) to hold the cable in place.

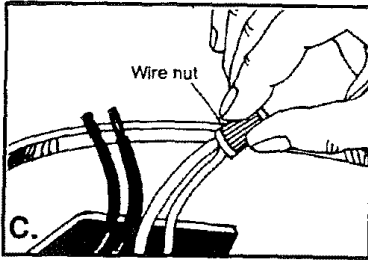

Connect the two power wires to the cable wires, making sure you connect **white to white** and **black to black**. Secure the wires with wire nuts by twisting them to the right (clockwise).

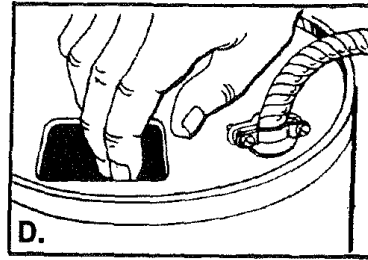

Finally, place the connected wires back in the compartment.

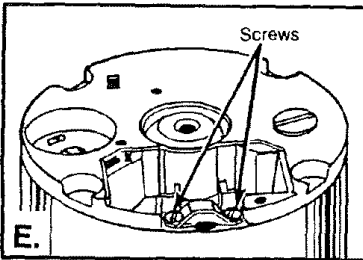

If you are using the built-in cable clamp **loosen** the two screws until cable will freely enter under the clamp.

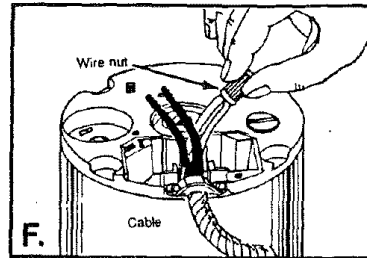

Work the cable from the on-off switch through the connector so that the leads are in the electrical wiring area in the disposer base.

Now, tighten the connector clamp screw(s) to hold the cable in place.

Connect the two power wires to the cable wires, making sure you connect **white to white** and **black to black**. Secure the wires with wire nuts by twisting them to the right (clockwise).

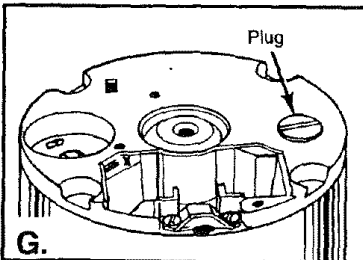

If you are using "Greenfield" Cable then the plug must be removed.

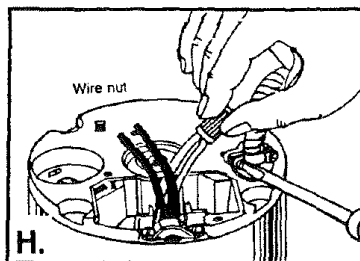

Install the cable connector. Then loosen the connector screw(s). Work the cable from the on-off switch through the connector so that the leads are in the electrical wiring area in the disposer base.

Now, tighten the connector clamp screw(s) to hold the cable in place.

Connect the two power wires to the cable wires, making sure you connect **white to white** and **black to black**. Secure the wires with wire nuts by twisting them to the right (clockwise).

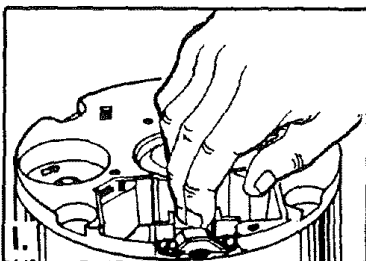

Finally, place the connected wires back in the compartment. Replace electrical plate.

12

NEXT, MAKE SURE THE DISPOSER IS GROUNDED.

If the cable leading to the disposer has three wires, attach the green ground wire to the green ground screw.

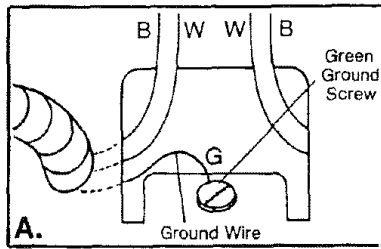

If the cable leading to the disposer does not have a ground wire, use a copper wire that is no smaller than the other wire in your cable. Attach one end of the wire to the green ground screw on the disposer.

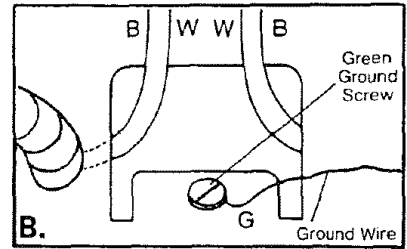

Attach the other end of this ground wire to the *metal* cold water pipe. **NOTE:** Be sure that this cold water pipe is continuous *metal* pipe from under the sink to the ground (earth). Use only an Underwriters Laboratories, Inc. listed (approved) ground clamp to attach the ground wire to the pipe. If non-metal pipe is used in your home water connections or if plastic pipe is used in your water supply pipe, you will need a qualified electrician to install a proper ground. Now, replace the electrical plate.

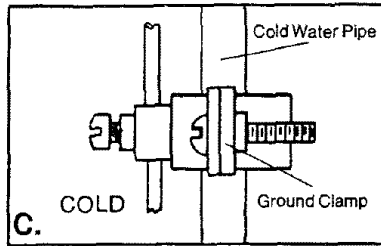

If you have a water meter in your home, check the meter to see if there is a wire that comes across it. If there is no wire, your cold water pipe is **NOT GROUNDED**.

To properly ground it, add a copper wire as shown at right. Use only Underwriters Laboratories, Inc. listed (approved) ground clamps to attach wire to pipe.

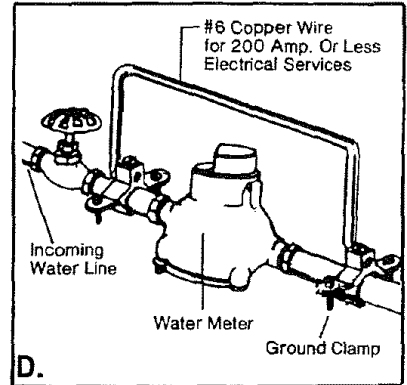

WARNING: IF NOT PROPERLY GROUNDED, a hazard of electrical shock may exist. **DO NOT** reconnect electrical power at main service panel until proper ground is installed. For your safety, **DO NOT** ground to a gas supply pipe.

13

PREPARING THE DISHWASHER DRAIN CONNECTION.

If you do **NOT** plan to connect a dishwasher drain to the disposer, go on to step 14.

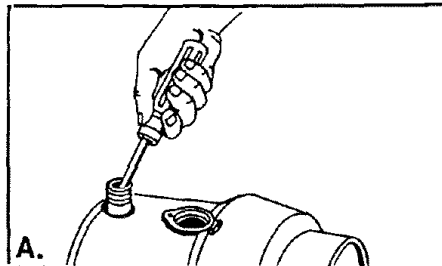

Lay the disposer on its side and put the tip of your screwdriver into the dishwasher drain hole opening at an angle.

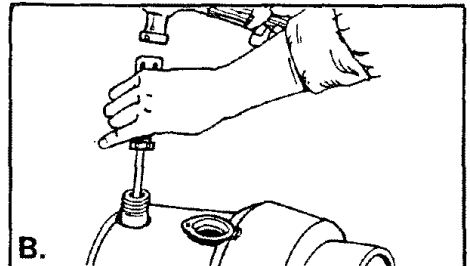

Tap the end of the screwdriver with a hammer until the molded plug pops out. **Make sure you take the loose plug out of your disposer.**

14

WE'RE ALMOST THERE. CONNECT THE DISPOSER TO ITS MOUNTING ASSEMBLY.

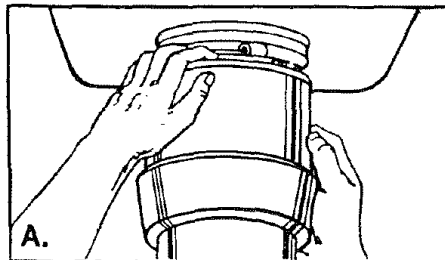

Lift the disposer and place it so the disposer's three mounting lugs are lined up *under* the three sink mounting assembly screws.

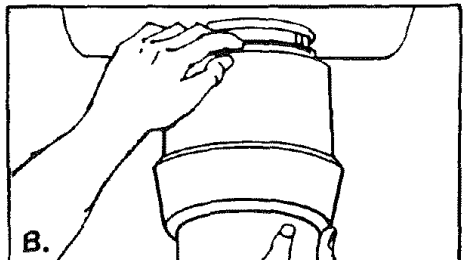

Then, while holding the disposer in place, turn mounting ring with the lugs to the right until all *three* ears are engaged on the mounting assembly. The disposer will now hang by itself. You will lock this ring later, after the plumbing connections are made.

15

NOW, ATTACH THE DISPOSER DISCHARGE TUBE TO YOUR SINK'S DRAIN TRAP.

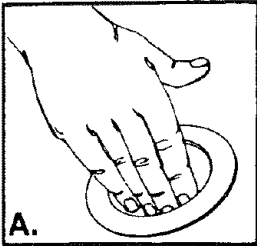

First, check inside the disposer grinding chamber to remove any objects or dirt that might have dropped in.

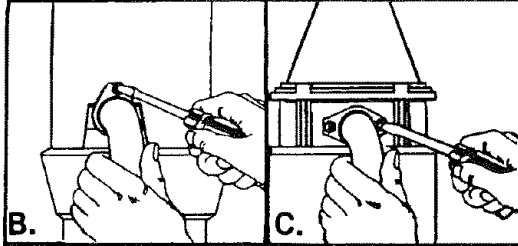

Turn the disposer around to attach the discharge tube. Some models use a rubber washer that must be assembled to the discharge tube before putting the metal flange over the discharge tube, see 'D'. Secure metal flange using the edge tab on the flange and screw. On other models, put the rubber washer in the discharge tube opening. Slip the metal flange over the discharge tube. Using the screw(s) provided, attach the flange to disposer, see 'E'.

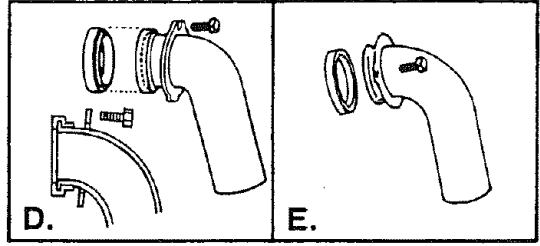

In D, install the discharge tube gasket onto the discharge tube. Gasket must be installed as shown to assure a leak-proof installation. In E, install discharge tube gasket into disposer discharge outlet. Gasket will be held in place by the discharge tube flange.

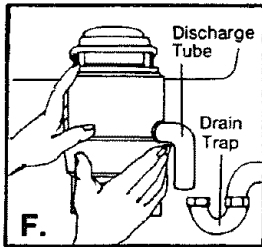

Turn the disposer so that the discharge tube lines up with your drain trap. Slip the drain trap over the discharge tube.

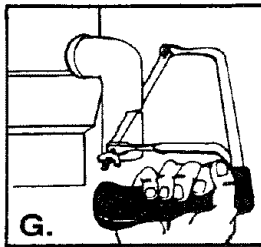

TUBE TOO LONG? Simply cut off as much as you need to with a hack saw. Make sure you have a clean, straight cut.

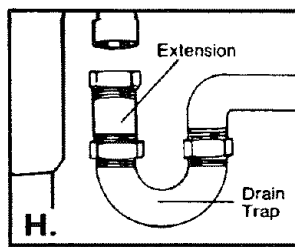

TUBE TOO SHORT? If the discharge tube doesn't reach your drain trap outlet, measure the difference. Then buy a drain extension tube.

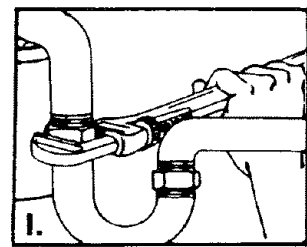

If it fits - simply tighten the slip nut on the trap with a pipe wrench to make your connection to the discharge tube complete.

NOTE: Be sure you comply with all applicable plumbing codes.

16

DISHWASHER DRAIN CONNECTION.

NOTE: (If necessary) An approved dishwasher drain connection kit is available from Sears.

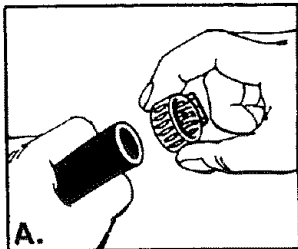

Remove the clamp or fittings from the end of your dishwasher drain hose.

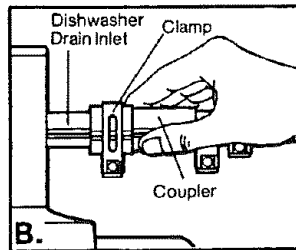

Slide large end of rubber coupler, from dishwasher drain connection kit, over the inlet tube of the disposer. Fasten the coupler to disposer with the clamp provided.

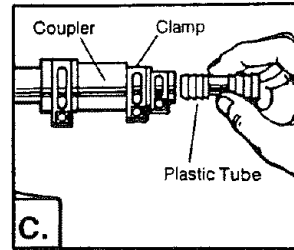

Insert one end of the plastic tube into the coupler and fasten with $\frac{3}{8}$ inch clamp.

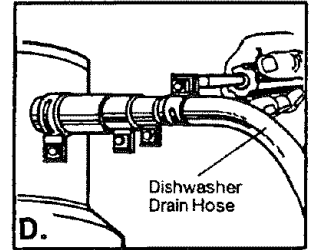

Slip the remaining clamp (the one you purchased) over the dishwasher drain hose and back two or three inches. Now, slip the drain hose over the plastic tube, slide the clamp into place and tighten.

NOTE: Check the three clamps to be sure you have tightened all of them.

17 NOW, LOCK THE DISPOSER IN PLACE.

Place the end of your "wrenchette" or a screwdriver into the left side of one of the mounting ring lugs at the top of the disposer. Then, turn the "wrenchette" or screwdriver to the right until the disposer locks in place.

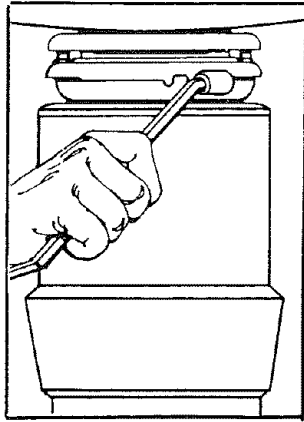

18 CHECK FOR LEAKS

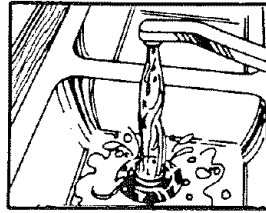

Run water through the disposer. Then, place the stopper in the sink sleeve in the seal position. Fill the sink with water.

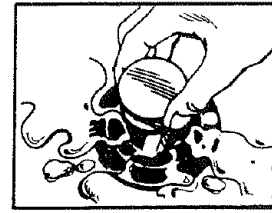

Finally, remove the stopper and let the water drain. Check for leaks at all plumbing connections and at the top of the disposer and correct, if you need to.

19 CHECK DISPOSER OPERATION

Turn electrical power back on at your service panel (fuse box or circuit breaker box). Turn on the cold water and leave running, turn on the disposer. You may wish to check again for leaks before turning the disposer off.

CARE AND USE OPERATING INSTRUCTIONS

CONTINUOUS FEED MODELS

Remove the stopper from the disposer throat. Turn on the cold water and start the disposer by using the control wall switch. Feed food waste into the disposer and position the stopper to minimize the possible ejection of material while grinding (see illustration.)

BATCH FEED MODELS

Remove the special stopper from the disposer throat. Turn on the cold water and then place the stopper into the disposer grind chamber. **DO NOT PACK THE CHAMBER WITH WASTE.** Replace the stopper in the disposer throat, and operate the disposer by lifting the stopper slightly turning it to the right or left until the disposer starts. The switch to the batch feed disposer is located into the unit and is actuated by the stopper.

WATER USAGE - ALL MODELS

The recommended water flow for efficient grinding

is 1 1/2 gallons per minute (medium to full faucet flow.) Remember to turn the water on first, and then the disposer to avoid a possible drain blockage. After grinding is complete, the disposer and water may be turned off.

Depending upon your particular installation, it may be necessary to allow a water flush after grinding to completely clear the horizontal drain line. The water flow time after grinding will depend on the quantity of food waste that was ground, and the length of the horizontal drain line. Ground food waste and water flow at an approximate rate of 2 seconds per foot in a properly pitched horizontal drain pipe.

REMEMBER THESE OPERATING INSTRUCTIONS WHEN USING YOUR DISPOSER.

- DO NOT INSERT HAND INTO THE DISPOSER.
- IF THE DISPOSER JAMS, OR THE MOTOR PROTECTOR TRIPS, DISCONNECT THE POWER TO THE DISPOSER BEFORE FREEING THE JAM, OR RESETTING THE MOTOR PROTECTOR.

WARNING

- USE THE STOPPERS IN THE DRAIN/GRIND POSITION WHILE GRINDING TO MINIMIZE POSSIBLE EJECTION OF MATERIAL.

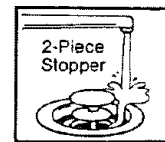
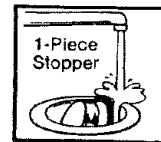

Stoppers are in drain/grind position.

DO'S AND DON'TS

grind food waste only with a strong flow of water.

Do not grind hard material such as bones, fruit pits, etc. A scouring action is created by the particles of the grind chamber.

Dispose of coffee grounds in your disposer regardless of whether or not you are on a municipal sewer or septic tank. Coffee grounds will not harm the action of the septic tank.

Dispose of small amounts of fats and greases in your disposer. Be sure to have the disposer running and use a strong flow of cold water. If you have a large amount of fat and grease, we suggest you place it in a container, allow it to solidify, then dispose of it in the trash.

Flush disposer for cleaning. Allow disposer to run for 30 seconds.

and cold water to run after grinding or after draining sink of dish water. Some detergents are caustic; flushing will pass such material into the drain line without disposer damage.

DON'T use hot water when grinding food waste. However, hot water can be drained into the disposer between grinding periods.

DON'T turn off motor or water until grinding is completed and only a motor and water sound is heard.

DON'T become alarmed if a brown discoloration appears on the face of the grinding disc. This is normal. It is a surface discoloration only and will not affect the life or performance of the disposer.

DON'T grind extremely fibrous material like corn husks, artichokes, etc. to avoid possible drain blockage.

If you should encounter an objectionable odor coming from your disposer, it may be the water itself, which in some areas develops a slight odor at times. Or it may be coming from bits of food waste left inside the disposer, because the unit was turned off before the grind cycle was completed or not enough water was used. Try this remedy, after all remaining food waste is disposed of inside the unit:

Heat a large pan of water (approximately 3 to 4 quarts). To this add one-half cup of baking soda. Mix in thoroughly so it is completely dissolved. When water reaches approximate boiling point, turn disposer on and pour heated mixture into sink. This hot, swirling, treated water will then flush the inside of the disposer housing.

INSTRUCTIONS PERTAINING TO A RISK OF FIRE, ELECTRICAL SHOCK, OR INJURY TO PERSONS.

IMPORTANT SAFETY INSTRUCTIONS

WARNING: When using electric appliances, basic precautions should always be followed, including the following:

1. Read all the instructions before using the appliance.
2. To reduce the risk of injury, close supervision is necessary when an appliance is used near children.
3. Do not put fingers or hands into a garbage disposer.
4. Turn the power switch to the off position before attempting to clear a jam or remove an object from the disposer.
5. When attempting to loosen a jam in a garbage disposer, use a self-service wrenchette as described below.
6. When attempting to remove objects from a garbage disposer use long-handled tongs or pliers.
7. To reduce the risk of injury by materials that may be expelled by a food waste disposer place the stopper in the drain grind position. Use care when feeding the food waste so that foreign

objects do not enter the grind chamber that may be expelled. Replace the anti-splash baffle when it becomes worn to reduce splashing and ejection.
Do not put the following into a disposer:

- a. Clam and oyster shells.
 - b. Drain cleaner.
 - c. Glass, china, plastic, plastic wrap or bags.
 - d. Large whole bones.
 - e. Metal, such as bottle caps, tin cans, aluminum foil or eating utensils.
8. When not operating a disposer, leave the drain cover in place to reduce the risk of objects falling into the disposer.
9. Before pressing red reset button, (see Fig. 4), be sure the wall switch is in the off position and on batch feed models remove the stopper from the run position.
10. a. **GROUNDING INSTRUCTIONS FOR CORD CONNECTED UNITS.** This appliance must be grounded. In the event of a malfunction or breakdown, grounding provides a path of least resistance for electric current to reduce the risk of electric shock. If this appliance is equipped with a cord having an equipment-grounding

conductor and a grounding plug, the plug must be plugged into an appropriate outlet that is properly installed and grounded in accordance with all local codes and ordinances.

DANGER - Improper connection of the equipment-grounding conductor can result in a risk of electric shock. Check with a qualified electrician or serviceman if you are in doubt as to whether the appliance is properly grounded. Do not modify the plug provided with the appliance — if it will not fit the outlet, have a proper outlet installed by a qualified electrician.

- b. **GROUNDING INSTRUCTIONS FOR PERMANENTLY CONNECTED UNITS:** This appliance must be connected to a grounded, metal, permanent wiring system; or an equipment-grounding conductor must be run with the circuit conductors and connected to the equipment-grounding terminal or lead on the appliance.

SAVE THESE INSTRUCTIONS

USER MAINTENANCE INSTRUCTIONS

Trouble Shooting

Loud noises while your disposer is operating are usually caused by dropping metal objects into the disposer. To correct this, turn off the disposer switch and water. After grinding disc has stopped turning, investigate. Remove object by reaching into unit with tongs.

Motor stops while your disposer is operating. This can be caused by overloading the unit. First, check the cause of the overload - often some foreign material is in the disposer. To avoid personal injury turn

off the disposer switch and water. Remove the object as previously explained. TO RESTART THE MOTOR: wait 3 to 5 minutes, then push in on the small red reset button located on the bottom of your disposer (Fig. 1). If motor remains inoperative, check your Service Panel and replace any blown fuses, or look for a tripped circuit breaker.

NOTE: If water does not drain as readily as you think it should, and food waste tends to float or take too long to grind, don't reduce

water flow to solve this problem. It is very likely that the drain line is partially clogged and should be cleaned with a drain auger. A blocked drain may also cause food waste to drain into the dishwasher. Like any precision machine, your disposer was built to perform a particular job. If unusual demands are placed on it, service interruptions are possible. These service interruptions, mentioned below, are usually not serious and in most cases, can be remedied without calling a service technician.

To Save The Cost of a Service Call to Free a Jam.

To save the cost of a service call to free a jam. The accidental entry of foreign material will cause any disposer to jam occasionally. To free jammed material, follow these steps to avoid personal injury:

1. Turn off disposer and shut off cold water.
2. Insert one end of your Self-Service Wrenchette provided with your disposer, into the center hole of the bottom of the disposer as shown. (Fig. 2).
3. Work the Wrenchette back and forth until it moves freely for at least one complete revolution. Remove foreign object with tongs. Remove Wrenchette before restarting disposer.
4. Wait 3 to 5 minutes to allow disposer motor to cool and then push red reset button, (Fig. 1). Before pressing red reset button be sure the wall switch is in the off position and on batch feed models remove the stopper from the run position.

Your Self-Service Wrenchette will free virtually every jam that may occur due to foreign objects entering the disposer. Very rarely, however, a piece of metal (bobby pin, thumb tack, paper clip, silverware, etc.) causes a jammed condition too tight for your Self-Service Wrenchette to handle. To free this type of jam, a pry bar or tool must be used.

Be sure wall switch is turned off. Remove as much food waste from the disposer as is possible with tongs. Use a flashlight to determine the direction the unit was running at the time of the jam.

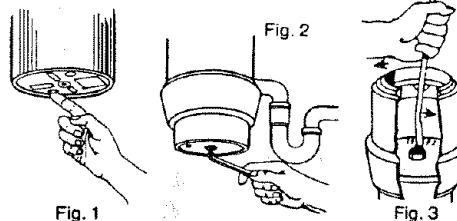

A pry bar or tool should be inserted through the sink opening into the disposer. The end then must be placed alongside the grinding protrusion near the outside edge of the grinding disc. Be sure to place the pry tool on the proper side of the protrusion so when pressure is applied the grinding disc will move in the proper direction to unjam the disposer. (see Fig. 3). Do not drop or hammer on pry bar.

LOSE YOUR SELF SERVICE WRENCHETTE?

If you lose your Self-Service Wrenchette, a replacement may be ordered, free of charge, through the Customer Service Department of your local Sears store or service center. Part number of the wrench is 2035.03.

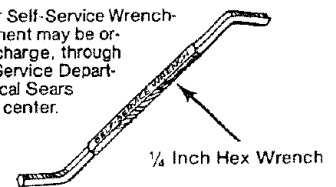

When warranty service is needed, simply call the nearest Sears Service Center in the United States. "We service what we sell" is our assurance to you that you can depend on Sears for service and Sears service is nationwide.

SEARS

Sears, Roebuck and Co., Hoffman Estates, IL 60179 U.S.A.